

Compliance code

Managing asbestos in workplaces

Edition 2

December 2019



Contents

Preface	2
Introduction	3
Purpose	3
Scope	3
Application	4
Consultation	5
General requirements of Part 4.4 of the Occupational Health and Safety Regulations 2017	6
Duty to control exposure to airborne asbestos fibres	6
Prohibitions	10
Prohibitions under the <i>Dangerous Goods Act 1985</i>	11
General exclusions	11
Manufacture of asbestos	11
Supply, storage, transport, sale, use, re-use, installation and replacement of asbestos. . .	11
Duties applying subsequent to importing goods that may or are suspected of containing asbestos. . .	12
Prohibitions under the <i>Occupational Health and Safety Act 2004</i>	14
Asbestos removal work	14
Removal of contaminated protective clothing	14
Use of certain tools or instruments on asbestos	16
Use of compressed air and other compressed gases	17
Asbestos in workplaces	18
Duty to identify asbestos	18
Persons identifying asbestos	21
How to identify asbestos	22
Assuming asbestos to be present	24
Inaccessible areas likely to contain asbestos	25
Information to be recorded when asbestos has been identified	27
Taking asbestos samples	28
Analysis of asbestos samples	29
Asbestos register	30
Duty to record results of identification in an asbestos register	30
Information that must be recorded in an asbestos register	30
Access to the asbestos register	31
Reviewing the asbestos register	33
Keeping a copy of the asbestos register	34
Indicating the presence of asbestos	35
Controlling risks to health associated with the presence of asbestos	37
Deciding if there is a risk to health that needs controlling	37
Controlling risk using the hierarchy of control	38

Proper installation and maintenance of risk control measures.	42
Information, instruction, training and supervision	43
Demolition and refurbishment	44
Definition of the terms 'demolition' and 'refurbishment'.....	44
Duties of employers or self-employed persons performing minor or routine maintenance work or work of a minor nature.	45
Duties that apply if no asbestos register exists for the workplace.	48
Identification and removal of asbestos before demolition or refurbishment	49
Workplace emergency where asbestos is present.	52
Asbestos management plan	54
Asbestos-related activities	57
Identifying regulated asbestos-related activities.	57
Information, instruction, training, and supervision.	58
Information to job applicants.	59
Employer's duty to control risks to health associated with asbestos-related activities. ...	59
Employer's duty to review and revise risk control measures.	63
Signs and barricades to be used and work area to be separated	63
Cleaning the work area	64
Using and emptying Dust Class H vacuum cleaners.	65
Medical examinations for employees engaged in asbestos-related activities	67
Decontamination at the end of the activity.	68
Employer's duty to contain and dispose of asbestos waste.	70
Laundering of clothing contaminated with asbestos	73
Appendix A – The compliance framework	75
Appendix B – Definitions	76
Appendix C – Taking asbestos samples	80
Appendix D – Example of an asbestos register	82
Appendix E – Asbestos register duties	84
Appendix F – Signs and labels	85
Appendix G – Asbestos-related activities	86
Appendix H – Selection and use of personal protective equipment and clothing for asbestos-related activities	87
Appendix I – Exposure standard and atmospheric monitoring	95
Appendix J – Sealing asbestos cement sheeting	98
Appendix K – Drilling of asbestos-containing material	101
Appendix L – Cleaning debris from asbestos cement roof gutters	105
Appendix M – Replacing cabling in asbestos cement conduits or boxes	107
Appendix N – Working on electrical mounting boards (switchboards) containing asbestos	110
Appendix O – Working with asbestos friction materials and high-temperature gaskets	113
Appendix P – Examples of asbestos-containing materials	116
Appendix Q – Information required to be included in an asbestos control plan	119
Appendix R – Documents associated with this compliance code	120

WorkSafe Victoria is a trading name of the Victorian WorkCover Authority.

© WorkSafe Victoria

The information contained in this publication is protected by copyright. WorkSafe Victoria hereby grants a non-exclusive licence in this publication to the recipient on the condition that it is not disseminated for profit. WorkSafe Victoria encourages the free transfer, copying and printing of the information in this publication if such activities support the purpose and intent for which the publication was developed.

This Compliance Code (Code) provides practical guidance for those who have duties or obligations in relation to asbestos under the *Occupational Health and Safety Act 2004* (OHS Act) or the Occupational Health and Safety Regulations 2017 (OHS Regulations).

The Code was developed by WorkSafe Victoria (WorkSafe). Representatives of employers and employees were consulted during its preparation. It was made under the OHS Act and approved by Robin Scott MP, Minister for Finance.

Duty holders under the OHS Act and OHS Regulations should use the Code together with this legislation. This Code replaces the *Managing asbestos in workplaces* (2008) code, which is no longer in force and effect.

While the guidance provided in the Code is not mandatory, a duty holder who complies with the Code will – to the extent it deals with their duties or obligations under the OHS Act and OHS Regulations – be considered to have complied with those duties or obligations.

If conditions at the workplace or the way work is done raise different or additional risks not covered by the Code, compliance must be achieved by other means. WorkSafe publishes guidance to assist with this at [worksafe.vic.gov.au](https://www.worksafe.vic.gov.au).

Failure to observe the Code may be used as evidence in proceedings for an offence under the OHS Act or OHS Regulations. However, a duty holder will not fail to meet their legal duty or obligation simply because they have not followed the Code.

A WorkSafe inspector may cite the Code in a direction or condition in an improvement notice or a prohibition notice as a suggested means of achieving compliance.

A health and safety representative (HSR) may cite the Code in a provisional improvement notice when providing directions as to how to remedy an alleged contravention of the OHS Act or OHS Regulations.

Approval for the Code may be varied or revoked by the Minister. To confirm the Code is current and in force, go to [worksafe.vic.gov.au](https://www.worksafe.vic.gov.au).

1. Exposure to airborne asbestos fibres through inhalation can cause a range of debilitating medical conditions affecting the respiratory system, including mesothelioma, asbestosis and lung cancer. These asbestos-related conditions are life threatening and severely affect a person's quality of life.

For further information about the risks to health from airborne asbestos fibres go to [worksafe.vic.gov.au](https://www.worksafe.vic.gov.au).

Purpose

2. The purpose of this Code is to provide practical guidance to duty holders on how to comply with their duties under the OHS Act and 'Part 4.4 – Asbestos' of the OHS Regulations in relation to managing asbestos.

Scope

3. This Code provides information about situations (except asbestos removal work) where a risk to health could arise from exposure to asbestos in a workplace, including:
 - where asbestos is present in a building, structure, ship or plant, or has been identified elsewhere at the workplace
 - demolition works on a building, structure, ship or plant where asbestos is present
 - activities involving asbestos.
4. It is not possible for this Code to deal with every risk arising from asbestos a duty holder may encounter at their workplace. The guidance in this Code needs to therefore be considered with regard to the particular characteristics and circumstances of the workplace.

For guidance about removing asbestos see WorkSafe's *Removing asbestos in workplaces compliance code* (2018).

For information on the transport and disposal of asbestos waste go to [epa.vic.gov.au](https://www.epa.vic.gov.au).

Application

5. This Code applies to a range of duty holders, including:
- persons who have management or control of a workplace
 - employers at a workplace where asbestos is present
 - employers or self-employed persons performing demolition or refurbishment work at a workplace where asbestos is present
 - employers engaged in asbestos-related activities at a workplace.

Additionally, it may be useful for HSRs and employees (including independent contractors) who are involved in or affected by the management of asbestos in a workplace, demolition or refurbishment work, or asbestos-related activities.

6. In general, duty holders have a range of duties associated with controlling risks associated with the presence of asbestos in workplaces (including the elimination of exposure of persons to an atmospheric concentration of asbestos fibres that exceeds the asbestos **exposure standard**).
7. Although duties are generally subject to what is reasonably practicable, the ultimate goal is for workplaces to be free of asbestos.

For information about what 'reasonably practicable' means see the WorkSafe Position – *How WorkSafe applies the law in relation to reasonably practicable at worksafe.vic.gov.au*.

Note: The word 'must' indicates a legal requirement that has to be complied with. The words 'need/s to' are used to indicate a recommended course of action in accordance with duties and obligations under Victoria's health and safety legislation. The word 'should' is used to indicate a recommended optional course of action (for the definition of key terms used in this Code see 'Appendix B – Definitions' on page 76).

Key abbreviations used in this Code

ACM:	asbestos-containing material
AC:	asbestos cement
ACD:	asbestos-contaminated dust
AIOH:	Australian Institute of Occupational Hygienists
Code:	Compliance Code
DWG:	designated work group
F/ml:	fibres per millilitre
HEPA filter:	high efficiency particulate air filter
HSR:	health and safety representative
MFM:	Membrane Filter Method
NATA:	National Association of Testing Authorities
OHS Act:	Occupational Health and Safety Act 2004
OHS Regulations:	Occupational Health and Safety Regulations 2017
PPE:	personal protective equipment
RPE:	respiratory protective equipment
RTO:	Registered Training Organisation
SDS:	safety data sheet
SWA:	Safe Work Australia
SWMS:	safe work method statement

Consultation

- Employers must, so far as is reasonably practicable, consult with employees and HSRs, if any, on matters related to health or safety that directly affect, or are likely to directly affect them. This duty to consult also extends to independent contractors (including any employees of the independent contractor) engaged by the employer in relation to matters over which the employer has control. [OHS Act s35](#)

Note: The characteristics of the workplace will have an impact on the way consultation is undertaken. For example, consider:

- the size and structure of the business
- the nature of the work
- work arrangements (such as shift work)
- characteristics of employees (such as language or literacy).

For more information on consultation go to [worksafe.vic.gov.au](https://www.worksafe.vic.gov.au).

- An employer has a duty to consult with employees (including HSRs, if any) when, for example, identifying or assessing hazards or risks to health or safety at the workplace, making decisions about measures to control such risks and proposing changes that may affect the health or safety of employees at the workplace. [OHS Act s35](#) It is important to consult with your employees as early as possible when planning to introduce measures identified in this Code or making decisions to implement alternative measures.
- Employers who are required to consult on a matter must share information about the matter with employees, including relevant independent contractors and HSRs (if any), give them a reasonable opportunity to express their views, and take those views into account before making a decision. If employees are represented by an HSR, the consultation must involve that HSR (with or without the involvement of the employees directly). If the employer and the employees have agreed to procedures for undertaking consultation, the consultation must be undertaken in accordance with those procedures. [OHS Act s35](#)

For more information on consultation go to [worksafe.vic.gov.au](https://www.worksafe.vic.gov.au).

❖ General requirements of Part 4.4 of the Occupational Health and Safety Regulations 2017

Duty to control exposure to airborne asbestos fibres

11. A person who manages or controls a workplace must, so far as is reasonably practicable, eliminate the exposure of persons at the workplace to airborne asbestos fibres. If it is not reasonably practicable to eliminate that exposure, they must reduce that exposure so far as is reasonably practicable. [OHS Regulations r209\(1\)](#) Other key requirements include:
- a person who manages or controls a workplace must ensure that:
 - a person at the workplace is not exposed to an atmospheric concentration of asbestos fibres in excess of the **asbestos exposure standard** [OHS Regulations r209\(2\)](#)
 - a determination of an employee's exposure to airborne asbestos fibres at the workplace is carried out if there is uncertainty (based on reasonable grounds) as to whether the asbestos exposure standard has been exceeded [OHS Regulations r209\(3\)](#)
 - copies of the results of **atmospheric monitoring** are readily accessible to an employer at the workplace (see Appendix I for more information about atmospheric monitoring). [OHS Regulations r209\(4\)](#)
12. An employer or self-employed person must, so far as is reasonably practicable, eliminate the exposure of persons at the workplace to airborne asbestos fibres, arising from the undertaking of the employer or self-employed person. If it is not reasonably practicable to eliminate that exposure, the employer or self-employed person must reduce that exposure so far as is reasonably practicable. [OHS Regulations r210\(2\)\(3\)](#) Other key requirements include:
- an employer must ensure that:
 - a person is not exposed to an atmospheric concentration of asbestos fibres arising from the conduct of an undertaking of the employer in excess of the asbestos exposure standard [OHS Regulations r210\(1\)](#)
 - a determination of an employee's exposure to airborne asbestos fibres at the workplace is carried out if there is uncertainty (based on reasonable grounds) as to whether the asbestos exposure standard has been exceeded [OHS Regulations r211](#)
 - a self-employed person must ensure that:
 - a person is not exposed to an atmospheric concentration of asbestos fibres arising from the conduct of an undertaking of the self-employed person in excess of the asbestos exposure standard. [OHS Regulations r210\(1\)](#)

General requirements of Part 4.4 of the Occupational Health and Safety Regulations 2017

An employer must ensure that copies of the results of atmospheric monitoring for airborne asbestos fibres at the workplace are readily accessible to the HSR of any affected DWG and to affected employees.
OHS Regulations r212

13. An employer's duty to, so far as is reasonably practicable, provide and maintain a working environment that is safe and without risks to health, and to consult with employees, extends to independent contractors and employees of independent contractors at the workplace.
OHS Regulations r8
14. **Employees**, while at work, have a duty to take reasonable care for their own health and safety and that of others who could be affected by their acts or omissions in the workplace. Employees must also cooperate with their employer's actions in relation to complying with duties under the OHS Act or OHS Regulations in order to make the workplace safe (for example, by following any information, instruction or training provided by the employer).
OHS Act s25(1)(c), s25(2)

Asbestos exposure standard

0.1 fibres per millilitre (f/ml) of air measured in a person's **breathing zone** and expressed as a time weighted average fibre concentration of asbestos calculated over an eight-hour working day and measured over a minimum period of four hours in accordance with:

- (a) the Membrane Filter Method, or
- (b) a method determined by WorkSafe.

Note: If WorkSafe makes a determination of an exposure measurement method it will publish a notice in the Government Gazette and, as soon as reasonably possible, in a newspaper circulating generally throughout Victoria. For further information go to worksafe.vic.gov.au.

Note: Respiratory protective equipment (RPE) should not be considered when establishing whether there is a risk of exposure to airborne asbestos fibres.

For more information about the asbestos exposure standard and atmospheric monitoring see 'Appendix I – Exposure standard and atmospheric monitoring' on page 95.

General requirements of Part 4.4 of the Occupational Health and Safety Regulations 2017

Determining who has management or control of the workplace

15. To determine who has management or control of a workplace (or plant within a workplace), it is necessary to consider matters such as ownership and who can make changes to the workplace or plant.

Ownership

An **owner of a commercial property who leases or rents the property to one or more employers (but does not occupy the property)** will typically have management or control over:

- the building (including walls, floor and roof), and
- associated plant that forms part of the building or structure (eg a lift, boiler, air-conditioner).

An **employer or self-employed person who occupies and owns a property** will typically have management or control of the building, associated plant that forms part of the building or structure and any plant that they own and use at the workplace.

Who can make changes

In general, the extent to which an **employer or self-employed person who leases a building** can undertake structural changes, for example, by installing lighting into a ceiling, will typically depend on the terms of the lease agreement. Therefore, the extent to which an employer or self-employed person has management or control of a workplace may vary from workplace to workplace.

Where a **building is leased to multiple tenants** (who are employers or self-employed persons), management or control may be shared by those tenants and the owner of the premises.

An **employer or self-employed person who occupies but does not own the property** should review their lease (or similar agreement) as a way of determining the extent of their management or control in relation to the building and any associated structures and plant. An employer or self-employed person may have management or control over any plant that they own and use at the workplace

Delegation of responsibilities

The owner of commercial property that is a workplace, may delegate the responsibility associated with the management or control of that workplace to, for example, a **commercial property agent or manager**. Although such delegation may include the management of any asbestos present in that workplace, the owner cannot delegate their duties under the OHS Act and OHS Regulations.

In other words, the owner of commercial property may ultimately be in contravention of, for example, a duty in relation to asbestos management in a workplace under the OHS Regulations and face enforcement action (including prosecution) in the event that its agent or manager contravenes that duty.

Where management of asbestos is delegated, the property owner needs to ensure that its agent or manager is competent to manage exposure to asbestos.

General requirements of Part 4.4 of the Occupational Health and Safety Regulations 2017

The following examples illustrate instances where employers or self-employed persons who lease workplaces (where the building requires maintenance or repairs) may not have management or control of asbestos:

- Sealed building riser shafts that contain asbestos insulation.
- Leaking/damaged asbestos cement (AC) roofing.
- Plant rooms or lifts that contain asbestos.
- Ceiling spaces that contain asbestos.
- Fire doors that contain asbestos.

Contractual leasing agreements should be examined in these scenarios as a way of determining the extent of an employer or self-employed person's management or control over asbestos.

Determining who has management or control of plant or structures in the workplace

16. If an employer or self-employed person purchases/owns or hires/rents plant or structures that contain asbestos, they are deemed to have management and control over that plant or structure. For example, if an employer owns a press machine fitted with asbestos-containing brakes, the employer is responsible for the management and control of risks associated with the presence of asbestos in relation to that plant.

Prohibitions

17. The Australian Government prohibits the import and export of asbestos and goods containing asbestos under the Commonwealth Customs (Prohibited Imports) Regulations 1956 and the Commonwealth Customs (Prohibited Exports) Regulations 1958. For more information go to **border.gov.au**.
18. The OHS Regulations contain prohibitions made under the OHS Act and *Dangerous Goods Act 1985* which complement these restrictions and apply to workplaces.

❖ Prohibitions under the *Dangerous Goods Act 1985*

General exclusions

OHS Regulations r217

19. Prohibitions on the supply OHS Regulations r219, storage OHS Regulations r220, transport OHS Regulations r221, sale OHS Regulations r222, use OHS Regulations r223, and re-use OHS Regulations r224(c) of asbestos do not apply:
- for the purposes of:
 - scientific analysis or research, or
 - sampling and identification, or
 - retention of asbestos samples for demonstration, education or practical training purposes, or
 - non-asbestos mining or the extraction of stone if asbestos is encountered
 - to soil from which visible asbestos-containing material (ACM) has been removed, so far as is reasonably practicable, by the person proposing to supply, store, transport, sell, use, or re-use the soil.
20. For further information about asbestos-contaminated soil see page 108 of *WorkSafe's Removing asbestos in workplaces compliance code* (2018).

Manufacture of asbestos

21. A person must not manufacture ACM. OHS Regulations r218 While the manufacture of ACM is prohibited in Victoria, asbestos is still widely used in some countries.

22. For information concerning importers of goods from countries which still manufacture ACM (including importers who subsequently supply any person with such goods), see paragraphs 23 to 29.

Supply, storage, transport, sale, use, re-use, installation and replacement of asbestos

23. A person must not supply (for example, sell or hire) to any person OHS Regulations r219, store OHS Regulations r220, transport OHS Regulations r221, sell OHS Regulations r222, or use OHS Regulations r223 asbestos, except where it was fixed to or installed in a building, structure, ship, plant, aircraft or vehicle as at 31 December 2003. This ensures that workplaces, plant, and vehicles may continue to be sold and used after the date the prohibitions came into force (for more information on asbestos in workplaces see 'Asbestos in workplaces' on page 18).
24. The prohibitions on storage and transport do not apply to asbestos waste or non-disposable clothing likely to be contaminated with asbestos for the purposes of disposal or laundering (for more information see 'Disposal of asbestos waste' on page 72 and 'Laundering of clothing contaminated with asbestos' on page 73. OHS Regulations r220(2)(a), r221(2)(a)

Prohibitions under the *Dangerous Goods Act 1985*

25. A person must not:
- fix ACM to, or install ACM in, any building, structure, ship, plant, aircraft or vehicle
 - replace any part of a building, structure, ship, plant, aircraft or vehicle with ACM
 - re-use any asbestos.
OHS Regulations r224

Note: This ensures that non-asbestos alternatives are used.

For example:

- If part of a building such as AC roofing needs replacement, it must be replaced with a non-asbestos alternative OHS Regulations r224. Other examples include vinyl floor tiles, internal and external AC sheet walls, asbestos-containing lagging, and other insulation materials such as millboard.
- If ACM has to be removed in preparation for the transport of a building, the removed ACM must not be re-used OHS Regulations r224 and must be disposed of as asbestos waste OHS Regulations r260, r280, r316.

Duties applying subsequent to importing goods that may or are suspected of containing asbestos

Note: the following information is intended to apply to goods imported after 31 December 2003.

26. In addition to the prohibition on importing asbestos containing goods (including plant, building products, and substances) into Australia (see paragraph 17), the duties under the OHS Regulations will apply, including the general prohibitions in relation to, for example, the sale, supply, and use of such asbestos containing goods in Victoria (see paragraph 23).

In the event a builder unknowingly imports asbestos containing building materials for use in a construction project in Victoria, the builder would be in contravention of the prohibition to import asbestos (see paragraph 17) as well as, for example, the prohibition to use asbestos (see paragraph 23). The builder may also be in contravention of, for example, other duties under the OHS Regulations in relation to failing to control risks associated with asbestos in relation to employees and other persons (for example, members of the public) which carry substantial penalties under the OHS Act.

27. Importers of goods from countries which still manufacture ACM (including importers who subsequently supply any person with such goods) need to be aware of the varying definitions and standards applied to manufactured products in the country of origin or supply. This is because local standards in some countries may classify, for example, plant, building materials, and substances as 'asbestos free' even if such goods meet a certain low level or trace amount of asbestos content. The supply, storage, transport, sale and use of such imported goods containing asbestos is prohibited in Victoria.

Prohibitions under the *Dangerous Goods Act 1985*

Specific examples of imported goods that may contain asbestos include:

- building materials (for example, cladding)
- talc (for example, talc used in industrial applications)
- motor vehicles, bikes and parts (eg brake pads, clutch mechanisms, high-temperature gaskets)
- mining and heavy industry equipment (for example, gaskets)
- ships and major industrial equipment (eg lagging, pressure vessel lining, high-temperature gaskets)
- trains and locomotives (eg brake shoes, insulation).

- arrange for an independent test of the plant/substances to be imported prior to shipping (testing needs to be undertaken by an approved asbestos laboratory in accordance with AS 4964-2004 *Method for the qualitative identification of asbestos in bulk samples*)
- inspect the goods on delivery.

An approved asbestos laboratory means a laboratory approved by:

- **National Association of Testing Authorities (NATA)** to perform asbestos fibre counting or to identify asbestos in samples, or
- by a scheme determined by WorkSafe. [OHS Regulations r5](#)

28. To assist compliance with the asbestos prohibitions, importers of goods from countries which still manufacture ACM (including importers who subsequently supply any person with such goods) need to:
- check product specifications and related documentation (for example, safety data sheets and technical data sheets)
 - include asbestos-free requirements in supply contracts
 - obtain certification from the manufacturer or supplier that the imported plant/substances are in fact asbestos-free (and do not contain low or trace amounts of asbestos)
 - obtain product testing results from the overseas manufacturer or supplier that confirms the plant/substances to be imported do not contain asbestos (testing needs to be undertaken by an **approved asbestos laboratory**)

Note: If WorkSafe makes a determination of a scheme for the approval of laboratories, it will publish a notice in the Government Gazette and, as soon as reasonably possible, in a newspaper circulating generally throughout Victoria. For further information go to worksafe.vic.gov.au.

29. If there is uncertainty, based on reasonable grounds, as to whether asbestos is present, asbestos must be assumed to be present or the analysis of a sample be undertaken by an approved laboratory (for more information see 'Duty to identify asbestos' on page 18) [OHS Regulations r226\(2\), r233\(2\)](#).

Note: For more information go to border.gov.au.

❖ Prohibitions under the *Occupational Health and Safety Act 2004*

Asbestos removal work

30. An employer, a self-employed person or a person who manages or controls a workplace must not perform **asbestos removal work**, or arrange for asbestos removal work to be performed, at a workplace unless the asbestos removal work:
- is conducted in accordance with 'Division 7 – Removal of asbestos' in 'Part 4.4 – Asbestos' of the OHS Regulations (see page 15 of WorkSafe's *Removing asbestos in workplaces compliance code* (2018) for information on asbestos removal work), or OHS Regulations r214(1)
 - is for the purpose of sampling and identification (for more information see 'Appendix C – Taking asbestos samples' on page 80), or OHS Regulations r214(2)(a)
 - is for the removal of asbestos encountered in the course of non-asbestos mining or the extraction of stone. OHS Regulations r214(2)(b)

Removal of contaminated protective clothing

31. An employer or self-employed person must not remove protective clothing contaminated with asbestos from a workplace unless the clothing is disposed of as asbestos waste or laundered at a laundry equipped to launder clothing contaminated with asbestos.
32. Where clothing is removed for disposal as asbestos waste, it must be disposed of as soon as is reasonably possible, in an appropriate manner that eliminates the release of airborne asbestos fibres, at a **waste disposal site licensed or exempted by the EPA**. OHS Regulations r215(1)(a)

A waste disposal site licensed or exempted by the EPA means premises:

- in respect of which the occupier is licensed by the EPA to dispose of asbestos waste
- to which regulation 12 of the Environment Protection (Scheduled Premises and Exemptions) Regulations 2007 applies in relation to the disposal, or
- set out in a classification under the Environment Protection (Industrial Waste Resource) Regulations 2009 that classifies asbestos waste as non-prescribed industrial waste.

Prohibitions under the *Occupational Health and Safety Act 2004*

33. Where non-disposable clothing is removed for laundering at a laundry equipped to launder clothing contaminated with asbestos, it must be contained so as to eliminate the release of airborne asbestos fibres (for example, double bagged in two 200 micron-thick asbestos waste bags). The exterior of the container must be decontaminated before being removed from the asbestos work area and must indicate the presence of asbestos (for example, labelled with an appropriate warning such as 'Caution Asbestos – Do not open or damage bag. Do not inhale dust') before being transferred to the laundry. [OHS Regulations r215\(1\)\(b\)](#)
34. An employer or self-employed person must ensure, so far as is reasonably practicable, that any person (for example, the launderer) is not exposed to risks to their health or safety arising from the conduct of the undertaking of the employer or self-employed person. [OHS Act s23, s24](#)
35. Protective clothing needs to be wetted down with a fine water mist before bagging to minimise the potential for asbestos fibres to become airborne. The launderer needs to be informed about the potential for asbestos contamination on the clothing prior to arrival at the laundry.

Note: Regulation r215(1) of the OHS Regulations does not apply where contamination of protective clothing arises from asbestos removal work under 'Division 7 – Removal of asbestos' or the carrying out of asbestos-related activities under 'Division 8 – Activities involving asbestos' in 'Part 4.4 – Asbestos' of the OHS Regulations. [OHS Regulations r215\(2\)](#)

This is because specific regulations apply to disposal or laundering where contamination of protective clothing arises from asbestos removal work (see pages 56 and 83 of WorkSafe's *Removing asbestos in workplaces compliance code* (2018) for more information) or an asbestos-related activity (see pages 70 to 74).

Prohibitions under the *Occupational Health and Safety Act 2004*

Use of certain tools or instruments on asbestos

36. An employer or self-employed person must not use or cause the following to be used on asbestos unless the use is controlled:

- brooms
- brushes
- high-pressure water jets, power tools or other similar tools or instruments.

OHS Regulations r216(1)

Note: The use of high-pressure spray equipment to clean ACM is not recommended as it is unlikely that exposure to airborne asbestos fibres will be able to be controlled.

Note: Brushes may be used for the purposes of sealing asbestos (for more information see 'Controlling risk using the hierarchy of control' on page 38).

37. This prohibition does not apply if airborne asbestos fibre levels are not in excess of 0.01 f/ml while the tool or instrument is in use. **OHS Regulations r216(2)**

38. The use of a tool or instrument is controlled if, while in use:

- the tool or instrument is enclosed (not the operator and tool or instrument together), or
- engineering controls are used (for example, extraction ventilation), or
- a combination of these methods is used

so that a person is not likely to be exposed to airborne asbestos fibres exceeding one half of the asbestos exposure standard (0.05 f/ml). **OHS Regulations r216(3)**

For example, a power tool may be used to drill holes in AC sheeting where a partial enclosure attached to a Dust Class H vacuum cleaner is placed over the point of drilling (see 'Using and emptying Dust Class H vacuum cleaners' on page 65). This is a combination of enclosure and an engineering control. If used correctly, these controls are likely to result in exposure of employees being below half the asbestos exposure standard.

39. An employer or self-employed person must not rely on respiratory protective equipment (RPE) to ensure that one half of the asbestos exposure standard is not exceeded (for more information about RPE see 'Appendix H – Selection and use of personal protective equipment and clothing for asbestos-related activities' on page 90). **OHS Regulations r216(4)**

40. For information about the decontamination of tools and equipment see page 69.

Atmospheric monitoring is the only method to determine if one half the exposure standard is being exceeded. Appropriate RPE needs to be worn by all persons in the area where atmospheric monitoring is undertaken. The type of RPE selected needs to be determined by a person with the requisite knowledge, skills and experience.

For more information about the asbestos exposure standard and atmospheric monitoring see 'Appendix I – Exposure standard and atmospheric monitoring' on page 95.

Prohibitions under the *Occupational Health and Safety Act 2004*

Use of compressed air and other compressed gases

41. An employer or self-employed person must not use or cause to be used compressed air or other compressed gases:

- on asbestos, except in areas enclosed to prevent the release of airborne asbestos fibres from the enclosed area, or [OHS Regulations r216\(5\)\(a\)](#)

For example, using compressed air to clean dust off asbestos-containing automotive brakes in an unenclosed area, such as a mechanics workshop is prohibited under the OHS Regulations.

- within six metres of an activity involving asbestos, unless the use of that air or gas does not result in airborne asbestos fibres that exceed one half of the asbestos exposure standard. [OHS Regulations r216\(5\)\(b\)](#)

For example, using a pneumatic (compressed air powered) tool within six metres of an area where hand drilling of AC sheet is being undertaken is prohibited under the OHS Regulations.

42. An employer or self-employed person must not rely on RPE to ensure that one half the exposure standard is not exceeded (for more information about RPE see 'Appendix H – Selection and use of personal protective equipment and clothing for asbestos-related activities' on page 87). [OHS Regulations r216\(6\)](#)

Atmospheric monitoring is the only method to determine if one half the exposure standard is being exceeded. Appropriate RPE must be worn by all persons in the area where atmospheric monitoring is undertaken. The type of RPE selected needs to be determined by a person with the requisite knowledge, skills and experience.

For more information about the asbestos exposure standard and atmospheric monitoring see 'Appendix I – Exposure standard and atmospheric monitoring' on page 95.

Asbestos in workplaces

43. The following information applies to a workplace where asbestos is present in a building, structure, ship or plant or has been identified elsewhere at the workplace. [OHS Regulations r225\(1\)](#) It does not apply to **domestic premises** (for more information see 'Domestic premises' on page 20). [OHS Regulations r225\(2\)](#)
44. See Appendix P for a list of common examples of materials in workplaces that may contain asbestos. This is not an exhaustive list and it should not be assumed that a material that is not listed is free of asbestos. For further information on asbestos-containing materials go to asbestos.vic.gov.au.

Note: For information concerning importers of goods from countries which still manufacture ACM (including importers who subsequently supply any person with such goods), see paragraphs 23 to 29.

Duty to identify asbestos

Duty of the person with management or control of the workplace

45. A person who manages or controls a workplace must, so far as is reasonably practicable, identify all asbestos present that is under their management or control. [OHS Regulations r226\(1\)](#) This could involve:
- Identifying the extent of areas over which a person has management or control to establish the scope of the duties by referring to property management documentation or contractual leasing arrangements (for example, considering the commercial lease between an owner of a commercial building who leases the building to a tenant who is an employer). The person with management or control of all the buildings and structures at the workplace needs to be established.
 - Obtaining information on the products used in making the building, structure, ship or plant (over which they have management or control) – this includes building plans, design papers and specifications, correspondence with builders and plant manufacturers. Employees in the workplace may be able to help determine if asbestos is present (including suspect asbestos). This information should be provided to the person who will identify where asbestos is in the workplace.

46. The results of an identification of asbestos must be recorded in an **asbestos register** which includes details of the location, form, type and condition of the asbestos (for more information see 'Asbestos register' on page 30).

Duty of the employer

47. An employer at a workplace must, if another person manages or controls the workplace, obtain from that person a copy of the asbestos register, and so far as is reasonably practicable, identify all asbestos present that is under the management or control of the employer, including ACM that is fixed to or installed in any plant under the management or control of the employer. [OHS Regulations r233\(1\)](#) This could involve:
- identifying the extent of areas over which they have management or control, including any buildings, parts of buildings or structures
 - identifying if there are any pieces of plant which they have management or control over that may contain asbestos (eg a press machine that has asbestos-containing brakes)
 - consulting the supplier, manufacturer or designer of the plant to determine if there is asbestos present
 - consulting with HSRs and employees who are familiar with the workplace to help determine if asbestos is present (including suspect asbestos).
48. The results of an identification of asbestos must be recorded in an **employer's asbestos register** which includes details of the location, form, type and condition of the asbestos (for more information see 'Asbestos register' on page 30).
49. An employer must notify the person who manages or controls the workplace about any risks that the employer identifies that are associated with the presence of asbestos under the control or management of the person who manages or controls the workplace and an activity carried out by the employer. [OHS Regulations r234](#)

Example 1

If an employer (who is a tenant of a building) is using a forklift to move and store pallets loaded with stock alongside an ACM wall, there may be a risk of damage to the wall and potential release of asbestos fibres in the air.

Informing the person who has management or control of the workplace (for example, the landlord of the building) of the potential risk may result in the implementation of a risk control measure, such as replacing the wall with non-asbestos materials or erecting bollards in front of the wall to prevent collisions.

Example 2

An employer identifies suspected ACD associated with an ACM lagged pipe in a plant room.

Informing the person who has management or control of the workplace of the potential risk may result in the implementation of risk control measures, such as isolating the area and engaging a Class A asbestos removal licence holder to remove the ACM lagged pipe and associated ACD.

Domestic premises

50. Domestic premises means premises used solely for domestic purposes.
OHS Regulations r5
51. The duties under 'Division 5 – Asbestos in workplaces' in 'Part 4.4 – Asbestos' of the OHS Regulations do not apply to domestic premises that become a workplace only because of work being performed by an employer or self-employed person engaged to perform the work (for example, demolition or refurbishment work or asbestos-related activities). OHS Regulations r225(2)
52. This means that duties under Division 5 to:
- identify asbestos
OHS Regulations r226, r233
 - notify the person who manages or controls the workplace about any risks associated with the presence of asbestos and activities carried out at the workplace
OHS Regulations r234
 - record the results of asbestos identification in an asbestos register/ employer's asbestos register
OHS Regulations r227, r235
 - review and revise the asbestos register/employer's asbestos register
OHS Regulations r228, r236
 - provide access to the asbestos register/employer's asbestos register
OHS Regulations r229, r237
 - provide a copy of the asbestos register to the person, if any, assuming management or control of a workplace
OHS Regulations r230
 - control risk associated with the presence of asbestos OHS Regulations r231, r238
 - review and, if necessary, revise any risk control measures associated with the presence of asbestos
OHS Regulations r232, r239
- do not apply to:
- employers or self-employed persons engaged to perform work at domestic premises OHS Regulations r225(2)
 - the owner of the domestic premises (for example, the homeowner or landlord)
 - the occupier of the domestic premises (for example, the homeowner or tenant)
 - the person who manages the domestic premises (for example, real estate agent).
53. Where an employer or self-employed person is engaged to carry out demolition or refurbishment work at domestic premises, it becomes the workplace of that person and the relevant duties under the OHS Act and 'Division 6 – Demolition and refurbishment where asbestos is present' of the OHS Regulations apply for the duration of the work (see 'Demolition and refurbishment' on page 44).
54. Where an employer is engaged to carry out an asbestos-related activity at domestic premises, it becomes the workplace of that person and the relevant duties under the OHS Act and 'Division 8 – Activities involving asbestos' in 'Part 4.4 – Asbestos' of the OHS Regulations apply for the duration of the work (see 'Asbestos-related activities' on page 57).

Example

The occupier of a house who has engaged an employer to perform plumbing services in their bathroom does not have a duty to identify if there is asbestos in their bathroom or home. However, the employer must identify whether an asbestos-related activity is being carried out (for example, the hand-drilling and cutting of ACM). **OHS Regulations r303** To identify whether an asbestos-related activity is being carried out, the employer needs to identify if asbestos is present in the bathroom area (for example, in the walls, ceiling, floors and waterproofing behind showers, baths and basins). If there is uncertainty (based on reasonable grounds) as to whether an activity is an asbestos-related activity, the employer must assume that asbestos is present or arrange for the analysis of a sample to be undertaken. **OHS Regulations r304**

Persons identifying asbestos

55. The person engaged to or undertaking asbestos identification needs to have the requisite knowledge, skills and experience to identify asbestos. A person who manages or controls a workplace or an employer at a workplace needs to take into account the following factors:
- background (for example, familiarity with building and construction practices to determine where asbestos is likely to be present)
 - training, including relevant qualifications
 - knowledge (for example, being able to determine if ACM is friable or non-friable and evaluate its condition)
 - skills, including specific expertise
 - experience in identifying suspect asbestos and being able to determine risk and appropriate risk control measures
 - professional affiliations (for example, membership of the Australian Institute of Occupational Hygienists)
 - referees and examples of reports prepared for other clients (as appropriate).

An example of a person with the requisite knowledge, skills and experience may be an occupational hygienist with experience in identifying asbestos and assessing its associated risks. A person may also be found at companies approved by the NATA for the identification of asbestos and via the **Australian Institute of Occupational Hygienists (AIOH)**.

56. The person undertaking asbestos identification needs to consult with, for example, the person who has management or control of the workplace, employers, and employees to obtain as much information as possible about the:
- workplace
 - construction of the workplace
 - location of any inaccessible areas likely to contain asbestos.

How to identify asbestos

When was the building or structure constructed?

57. When identifying whether asbestos is present at a workplace, the employer or person with management or control of the workplace needs to consider when any buildings and structures were constructed.
58. Asbestos was used in a wide range of building products and materials up until the mid to late 1980s. While some types of asbestos were banned in Victoria in 1992, the use of ACM in plant (such as brakes and gaskets) was permitted until 31 December 2003, when a total ban on the use of all forms of asbestos came into effect in Australia.
59. This ban complements Commonwealth Customs (Prohibited Imports) Regulations 1956 which prohibit the importation of asbestos. Despite this prohibition, imported plant and substances including gaskets, vehicles, plant, locomotives, and building products have been found to contain asbestos.

Importers of goods from countries which still manufacture ACM (including importers who subsequently supply any person with such goods) need to be aware of the varying definitions and standards applied to manufactured products in the country of origin or supply. This is because local standards in some countries may classify, for example, plant, building materials, and substances as 'asbestos free' even if such goods meet a certain low level or trace amount of asbestos content. The supply, storage, transport, sale and use of such imported asbestos containing goods is prohibited in Victoria (see 'Duties applying subsequent to importing goods that may or are suspected of containing asbestos' on page 12).

60. Note that ACM may have been illegally stockpiled, stored or recycled in Australia and used in the construction of buildings after the prohibitions in relation to asbestos came into force.

Were there any refurbishments or additions to the building or structure prior to the mid to late 1980s?

61. Any refurbishment or extensions to the original building or structure prior to the mid to late 1980s may have involved the use of ACM. While the original parts of the building may not contain asbestos, the absence of asbestos from subsequent additions should not be assumed.
62. Some building products are manufactured in countries where asbestos is still used. The supplier should be contacted to confirm that products have been tested by an approved asbestos laboratory and certification should be obtained that confirms products are asbestos-free (and do not contain low or trace amounts of asbestos).

Asbestos in workplaces

63. If the supplier cannot be contacted and there is uncertainty, based on reasonable grounds, as to whether asbestos is present, asbestos must be assumed to be present or the analysis of a sample be undertaken by an approved asbestos laboratory (for more information see 'Duty to identify asbestos' on page 18) [OHS Regulations r226\(2\), r233\(2\)](#).

Consider the type of materials that were used to construct the building or structure

64. If cement sheet is present it may contain asbestos fibres bonded to cement particles. For example, if a roof is made from corrugated cement sheeting which was installed before 31 December 2003, it may contain asbestos. The areas of the building prone to wet conditions (such as bathrooms, toilets and laundries) may have asbestos sheeting or asbestos vinyl tiles in the walls and floors due to the hardness and waterproofing qualities of asbestos compared to other materials. Likewise, pipes throughout the building that carry water and sewage may contain asbestos.

Talk to designers, manufacturers or suppliers of plant or refer to design plans

65. Asbestos may be present in plant (such as gaskets, insulation or brake mechanisms). Asbestos was widely used in the mid to late 1980s in gasket and friction brake products and despite a large reduction in its use, it was still known to be used in some applications until 31 December 2003. The person with management or control of plant that is likely to contain asbestos needs to talk to the supplier, manufacturer or designer of the plant, and the supplier or manufacturer of any replacement parts, to determine if asbestos is present and if

possible, obtain this advice in writing. If this is not possible, they need to engage a person with the requisite knowledge, skills and experience to identify any asbestos.

66. Some plant and parts of plant are manufactured in countries where asbestos is still used. The supplier should be contacted to confirm that suspect ACM has been tested by an approved asbestos laboratory and certification should be obtained that products are asbestos-free (and do not contain low or trace amounts of asbestos).

67. If the supplier cannot be contacted and there is uncertainty, based on reasonable grounds, as to whether asbestos is present, asbestos must be assumed to be present or the analysis of a sample be undertaken by an approved asbestos laboratory (for more information see 'Duty to identify asbestos' on page 18) [OHS Regulations r226\(2\), r233\(2\)](#).

Consult with employees who have worked at the workplace for a long time

68. Employers must consult with employees when identifying or assessing hazards or risks to health or safety at the workplace (including the risk of exposure to airborne asbestos fibres) (see 'Consultation' on page 5). [OHS Act s35](#)
69. Experienced employees may know where asbestos is located in the workplace. They may be aware of the history of the building including its age, construction and subsequent renovations or repairs.
70. A failure to consult may result in the omission of important knowledge from employees. Recording minutes of discussions with employees may assist in future asbestos register reviews.

Conduct a walkthrough inspection of the workplace to visually identify asbestos, materials that may contain asbestos, and inaccessible areas

71. A person who manages or control a workplace and an employer at a workplace must, so far as is reasonably practicable, identify all asbestos present that is under the person's or employer's management or control. [OHS Regulations r226\(1\), r233\(1\)\(b\)](#)
72. An identification of asbestos needs to include a thorough inspection of areas both inside and outside of a workplace (for example rooms, ceiling spaces, cellars, shafts, storage areas, wall cavities, and areas adjacent to buildings or structures).
73. The design plans for a building, structure, ship or plant may assist in identifying inaccessible areas as would discussion with builders, architects, manufacturers of plant and maintenance employees. Knowledge of materials used in the construction of the building or experience and findings from inspections of similar sections of the building (or similar buildings) may also assist in identifying asbestos.

Take notes and photographs

74. It is important for the person who inspects the workplace to take notes while the inspection is being conducted as the notes can be used to produce the asbestos register. The use of photographs may also supplement the information in the register (for more information see 'Asbestos register' on page 30).

Note: For further information about identifying asbestos go to worksafe.vic.gov.au.

Assuming asbestos to be present

75. If there is uncertainty (based on reasonable grounds) as to whether asbestos is present, or if there are inaccessible areas that are likely to contain asbestos, the person who manages or controls the workplace must assume that asbestos is present or arrange for analysis of a sample to be undertaken. [OHS Regulations r226\(2\)](#)
76. If there is uncertainty (based on reasonable grounds) as to whether any material of which the employer has management or control is asbestos, or if there are inaccessible areas that are likely to contain asbestos, the employer must assume that asbestos is present or arrange for analysis of a sample to be undertaken. [OHS Regulations r233\(2\)](#)
77. If there is uncertainty (based on reasonable grounds) as to whether dust is contaminated with asbestos a person must assume the dust is contaminated with asbestos or arrange for analysis of a sample to be undertaken (for more information see 'Taking asbestos samples' on page 28). [OHS Regulations r208](#)

Note: If samples are taken for the purpose of identifying if asbestos is present, it is important that representative samples are taken.

Reasonable grounds for assuming that asbestos is present in soil may include knowledge of:

- the presence of asbestos-contaminated soil in other areas of the workplace or in immediate and adjacent areas of the workplace
- the presence of naturally occurring asbestos at the workplace or in the surrounding areas
- use of recycled soil or fill at the workplace (unless visible ACM has been removed, so far as is reasonably practicable, by the person who supplied the soil)
- previous demolition or renovation work undertaken at the workplace on buildings or structures known or suspected to contain asbestos (unless a clearance certificate is available).

78. If asbestos is assumed to be present, it is taken to be identified for the purposes of 'Part 4.4 – Asbestos' of the OHS Regulations. [OHS Regulations r226\(3\), r233\(3\)](#) Therefore the duty to record the results of asbestos identification in an asbestos register or an employer's asbestos register applies to asbestos that is assumed to be present (see 'Asbestos register' on page 30).

Note: Sampling for analysis and identification purposes is not required if asbestos is assumed to be present.

Inaccessible areas likely to contain asbestos

79. If there is uncertainty (based on reasonable grounds) as to whether asbestos is present, or if there are inaccessible areas (for example, due to design or location) that are likely to contain asbestos, the person who manages or controls the workplace or the employer must assume that asbestos is present or arrange for analysis of a sample to be undertaken. [OHS Regulations r226\(2\), r233\(2\)](#)
- Note:** Sampling for analysis and identification purposes will require the area to be accessed.
80. A person with the requisite knowledge, skills and experience should determine if an inaccessible area is likely to contain asbestos in consultation with the person who has management or control of the workplace including any employers and employees.

Asbestos in workplaces

Examples of inaccessible areas likely to contain asbestos:

- A cavity in a building that is completely (or almost completely) enclosed and suspected of containing asbestos (based on where asbestos is located elsewhere in the building) and access is only possible through partial destruction of the walls of the cavity.
- The inner lining of an old boiler pressure vessel (information on this type of vessel suggests it contains asbestos) and the inner lining is not accessible due to the design and operation of the boiler and access can only be via partial destruction of the outer layer.
- Vinyl tiles that may contain asbestos, which have had a number of layers of non-ACM placed over them and secured – where the layers above it have been well secured and require some form of destruction in order to access the vinyl that may contain asbestos.
- Enclosed riser shafts in multi-storey buildings containing cables that may be insulated with ACM.
- Air-conditioning ducts that may contain asbestos gaskets or linings.

81. The following areas need to either be inspected or assumed to contain asbestos:

- locked rooms
- crawl spaces
- stairwells
- storage areas
- ceiling spaces
- basements and cellars
- locked security safes
- fire doors.

Fire doors and security safes – Accessing fire doors and security safe cores to determine whether they contain asbestos may result in creating a risk (for example, drilling resulting in the release of airborne asbestos fibres). Therefore, it is recommended that the core be assumed to contain asbestos until otherwise shown (ie during maintenance when access is obtained) or information on the presence of asbestos be sought from the supplier of the fire door.

82. Details of inaccessible areas that are likely to contain asbestos must be recorded in the asbestos register and employer's asbestos register (for more information see 'Asbestos register' on page 30).
OHS Regulations r227, r235

Risks relating to asbestos in inaccessible areas

83. If inaccessible areas likely to contain asbestos are not identified, this may present a risk to unsuspecting persons of being exposed to airborne asbestos fibres, for example during demolition, installation, maintenance, renovation, or repair activities as well as during emergencies such as the collapse of a building or structure due to fire or an accident.

Case study

A developer engaged a consultant to identify asbestos prior to buildings being demolished. A report prepared by the consultant stated that the site had been thoroughly inspected for the purposes of identifying the presence of asbestos and that the site only contained the asbestos identified in the report.

In the course of demolition, asbestos was disturbed in an inaccessible area which had not been mentioned in the report and the site was contaminated.

84. A person who manages or controls a workplace or an employer at a workplace needs to ensure that the person identifying asbestos has the requisite knowledge, skills and experience to determine if an inaccessible area is likely to contain asbestos (see page 18).
85. The person identifying asbestos must ensure, so far as is reasonably practicable, that they do not expose other persons to risks to their health or safety, this includes ensuring that inaccessible areas likely to contain asbestos are appropriately identified. OHS Act s23, s24

Information to be recorded when asbestos has been identified

OHS Regulations r226(4), r227(2)(c), r233(4), r235(2)(c)

86. Where asbestos is identified in the workplace, the date of each identification and specific information about its presence must be recorded in an asbestos register and employer's asbestos register (see page 30). The following information must be determined and recorded when conducting an inspection of the workplace to identify the presence of asbestos:
- What is the **location** of the asbestos?
- Example** – Building B, level 2, floor covering.
- What is the likely **source** of any asbestos that is **not** fixed or installed that has been identified during the inspection?
- Example** – broken pieces of AC sheet lying on the floor alongside an AC wall.
- What is the **type** of ACM?
- Example** – AC sheet, vinyl tiles, pipe lagging.

- Is the ACM **friable** or **non-friable**?

AC sheet is normally non-friable. Vinyl tiles are non-friable but sprayed insulation is typically friable.

- What is the **condition** of the ACM?

The material may be poorly bonded, deteriorated or falling apart due to exposure to weather and damage or it may be in good condition in an isolated indoor location.

- Is the ACM **likely to sustain damage or deterioration**?

Example – AC sheet walls with no protective bollards in the vicinity of moving plant (for example, forklifts).

- Are there any **activities** at the workplace that are likely to damage or disturb the asbestos?

Example – maintenance of plant with asbestos-containing parts.

Note: In relation to inaccessible areas that are likely to contain asbestos, the person who manages or controls the workplace and the employer must determine the location of the asbestos and the likely source of asbestos that is not fixed or installed so far as is possible. OHS Regulations r226(5), r233(5)

Friable: means, when dry –

- (a) may be crumbled, pulverised or reduced to powder by hand pressure, or
 - (b) as a result of a work process becomes such that it may be crumbled, pulverised or reduced to powder by hand pressure.
- OHS Regulations r5

Non-friable: means, when dry may not be crumbled, pulverised or reduced to powder by hand pressure.

Note: non-friable ACM may become friable as a result of work processes over time (for example, degradation due to chemical exposure) or due to other factors (for example, damage by fire).

Asbestos contaminated dust (ACD):

means, dust that is, or is assumed under 'Part 4.4 – Asbestos' to be, contaminated with asbestos. OHS Regulations r5

If there is uncertainty (based on reasonable grounds) as to whether dust is contaminated with asbestos a person must assume the dust is contaminated with asbestos or arrange for analysis of a sample to be undertaken.

OHS Regulations r208

Reasonable grounds for assuming asbestos to be present in dust may include knowledge of:

- the presence of ACM in other areas of the workplace or in immediate and adjacent areas of the workplace, for example:
 - dust surrounding an AC flue
 - dust on horizontal surfaces below an AC roof
 - dust in an electrical switchboard cupboard which has asbestos-backed panels.
- previous asbestos removal, demolition or renovation work undertaken at the workplace on buildings or structures known or suspected to contain asbestos (unless a clearance certificate is available).

Taking asbestos samples

87. If samples are taken for the purpose of identifying if asbestos is present, it is important that representative samples are taken. If there are any variations in appearance, texture or colour of the suspected ACM, additional samples need to be taken to ensure the analysis is accurate and valid. For example, full-thickness samples of friable material back to the substrate need to be taken. Consideration should also be given to taking samples from areas that are difficult to access where there is evidence of previous asbestos removals, for example, sub-surfaces or pipe joints.
88. A person carrying out sampling of suspected asbestos for the purpose of identification needs to have the requisite knowledge, skills and experience.
89. An employer must ensure that, when carrying out an asbestos-related activity (including sampling involving suspected asbestos), the activity is carried out in a manner that, so far as is reasonably practicable, eliminates the release of airborne asbestos fibres. OHS Regulations r306
90. An employer must, so far as is reasonably practicable, control any risk associated with carrying out an asbestos-related activity (including sampling involving suspected asbestos) by implementing risk control measures according to the hierarchy of control (see 'Employer's duty to control risks to health associated with asbestos-related activities' on page 59). OHS Regulations r307
91. For more information on how to take asbestos samples safely see 'Appendix C – Taking asbestos samples' on page 80.

Analysis of asbestos samples

92. If a sample of suspected asbestos is taken under 'Part 4.4 – Asbestos' of the OHS Regulations, it must be analysed by an **approved asbestos laboratory**.
OHS Regulations r213(1)
93. An approved asbestos laboratory means a laboratory approved by NATA to perform asbestos fibre counting or to identify asbestos in samples, or a scheme determined by WorkSafe.
OHS Regulations r5
Note: If WorkSafe makes a determination of a scheme for the approval of laboratories, it will publish a notice in the Government Gazette and, as soon as reasonably possible, in a newspaper circulating generally throughout Victoria. For further information go to **worksafe.vic.gov.au**.
94. The analysis results must be reported in accordance with the requirements of NATA or the scheme under which the laboratory was approved. OHS Regulations r213(2)
Endorsed reports have the NATA insignia stamped on the report. It is recommended that a copy of the endorsed report be retained.
95. The NATA website (**nata.com.au**) can be used to confirm whether a laboratory is approved to analyse samples of suspected asbestos.

Duty to record results of identification in an asbestos register

96. A person who manages or controls a workplace must record in an asbestos register the results of an identification of asbestos. [OHS Regulations r227\(1\)](#)
97. An employer at a workplace must record in an employer's asbestos register the results of an identification of asbestos. [OHS Regulations r235\(1\)](#) This includes ACM that is fixed to or installed in any plant under the management or control of the employer.
98. Depending on how many employers occupy a building, there may be two or more asbestos registers relating to the same workplace. The employer's asbestos register must contain a copy of any asbestos register obtained from the person who manages or controls the workplace. [OHS Regulations r235\(2\)\(d\)](#) Where the person who manages or controls the workplace is the employer who occupies the workplace, then one asbestos register covering both duties would be sufficient.

Note: The flow chart in Appendix E sets out duties related to asbestos registers.

Information that must be recorded in an asbestos register

99. The asbestos register must contain the following information (which is expected to be gathered as part of the asbestos identification as outlined on page 22):
 - the location of the asbestos
 - the likely source of asbestos that is not fixed or installed
 - in relation to ACM:
 - the type of ACM
 - whether the ACM is friable or non-friable
 - the condition of the ACM
 - whether the ACM is likely to sustain damage or deterioration
 - so far as is possible, any activities likely to be carried out at the workplace that are, in view of their nature or design, likely to damage or disturb the asbestos
 - details of all inaccessible areas that are likely to contain asbestos, and
 - date of each identification. [OHS Regulations r227\(2\)](#)

100. The employer's asbestos register must contain the following information (which is expected to be gathered as part of the asbestos identification as outlined on page 22):
- the location of the asbestos
 - the likely source of asbestos that is not fixed or installed
 - in relation to ACM:
 - the type of ACM
 - whether the ACM is friable or non-friable
 - the condition of the ACM
 - whether the ACM is likely to sustain damage or deterioration
 - so far as is possible, any activities likely to be carried out at the workplace that are, in view of their nature or design, likely to damage or disturb the asbestos
 - details of all inaccessible areas that are likely to contain asbestos
 - date of each identification
 - a copy of any asbestos register obtained if another person manages or controls the workplace, and
 - information in relation to any activity carried out by the employer that could give rise to a risk of exposure to airborne asbestos fibres. [OHS Regulations r235\(2\)](#)
101. The asbestos register and employer's asbestos register needs to contain a copy of all analysis reports of samples conducted by approved asbestos laboratories.

Note: There is no mandatory format for an asbestos register or employer's asbestos register. See Appendix D for an example of an asbestos register and a blank pro forma that can be used.

Access to the asbestos register

102. The OHS Regulations specify requirements in relation to who is entitled to access an asbestos register and who must be provided with a copy of an asbestos register (discussed in paragraphs 103 and 104).

The duty of the person who has management or control

103. A person who manages or controls a workplace must:
- (a) **Provide a copy** of the asbestos register to:
- any employer or self-employed person whose business is located at the workplace – this will assist the employer or self-employed person to determine whether any of their activities in the workplace are likely to disturb or damage that asbestos [OHS Regulations r229\(1\)\(a\)](#)
 - an asbestos removal licence holder engaged to do asbestos removal work – this will enable the asbestos removal licence holder to plan their work appropriately and safely [OHS Regulations r229\(1\)\(b\)](#)
 - an employer who is carrying out any of the following **asbestos-related activities** in the workplace and requests a copy:
 - research involving asbestos (if an asbestos register is available)
 - sampling or analysis involving suspected asbestos
 - the enclosing or sealing of asbestos
 - hand drilling and cutting of ACM
 - any other activity (other than asbestos removal work) that is likely to produce airborne asbestos fibres in excess of one half of the exposure standard (if an asbestos register is available)

– any other activity determined by WorkSafe to be an asbestos-related activity (if an asbestos register is available). OHS Regulations r229(1)(c)

▪ an employer or self-employed person who intends to occupy the workplace and requests a copy OHS Regulations r229(4)

▪ a person who is assuming management or control of the workplace. OHS Regulations r230

(b) **Inform** any person engaged to do work at that workplace that involves the risk of exposure to airborne asbestos fibres of the asbestos register and must **provide access** to that register. OHS Regulations r229(2)

The phrase 'risk of exposure' is not the same as 'risk to health'. A person with management or control of a workplace must determine, so far as is possible, any activities likely to be carried out at the workplace that are, in view of their nature or design, likely to damage or disturb the asbestos. OHS Regulations r226(4)(d) For example, a contractor undertaking work which may damage or disturb asbestos (such as moving pallets with a pallet jack near an AC wall with an unsealed surface) should be informed of the risk of exposure to asbestos by the person with management or control of the workplace (such as the building owner) so that additional controls can be implemented (such as a temporary barrier).

(c) **Provide access** to the asbestos register to any other person engaged by that person to do work at that workplace if access is requested. OHS Regulations r229(3)

The duty of employers

104. The employer must:

(a) **Ensure** that a copy of the employer's asbestos register is **readily accessible** to any employee of the employer. OHS Regulations r237(a)

(b) **Provide a copy** of the employer's asbestos register to:

▪ the HSR of an affected DWG OHS Regulations r237(b)(i)

▪ an asbestos removal licence holder who has been engaged to do asbestos removal work – this will enable the removalist to plan their work appropriately and safely OHS Regulations r237(b)(ii)

▪ an employer who is carry out any of the following asbestos-related activities in the workplace and requests a copy:

– research involving asbestos (if an employer's asbestos register is available)

– sampling or analysis involving suspected asbestos

– the enclosing or sealing of asbestos

– hand drilling and cutting of ACM

– any other activity (other than asbestos removal work) that is likely to produce airborne asbestos fibres in excess of one half of the exposure standard (if an employer's asbestos register is available)

– any other activity determined by WorkSafe to be an asbestos-related activity (if an asbestos register is available). OHS Regulations r237(b)(iii)

(c) **Inform** any person engaged to do work at the employer's workplace that involves the risk of exposure to airborne asbestos fibres of the employer's asbestos register and **provide access** to that register. OHS Regulations r237(c)

The phrase 'risk of exposure' is not the same as 'risk to health'. The employer must determine, so far as is possible, any activities likely to be carried out at the workplace that are, in view of their nature or design, likely to damage or disturb any asbestos at the workplace. [OHS Regulations r233\(4\)\(d\)](#)

For example, an employer must determine whether an employee undertaking an activity in an area of the workplace which contains asbestos (such as unloading goods from a pallet jack near an AC wall with an unsealed surface) would be likely to damage or disturb any asbestos at the workplace. If so, the employer can consider redesigning the work activities (such as using an alternative storage space) or implement additional controls (such as a temporary barrier).

(d) **Provide access** to the employer's asbestos register to any other person engaged to do work by the employer if access is requested. [OHS Regulations r237\(d\)](#)

Reviewing the asbestos register

Keeping the asbestos register current

105. The asbestos register and employer's asbestos register must be kept current by including:

- any change in the condition of asbestos (such as damage or deterioration from exposure to weather, substances or impacts)
- details of asbestos that has been removed, enclosed or sealed (and preferably by whom and when). [OHS Regulations r228\(1\), r236\(1\)](#)

106. If the HSR for an affected DWG so requests (on reasonable grounds) the employer must review and, if necessary, revise the employer's asbestos register. [OHS Regulations r236\(2\)](#)

The term 'on reasonable grounds' may mean where the HSR provides information to suggest that:

- material in the workplace was identified to contain asbestos and it is not included in the employer's asbestos register
- there has been a change to the condition of asbestos in the workplace that is included in the employer's asbestos register, or
- the current employer's asbestos register is out-of-date or incomplete.

107. The asbestos register and employer's asbestos register must be reviewed and, if necessary, revised **at least every five years** (even if there have been no changes to any asbestos at the workplace). [OHS Regulations r228\(2\), r236\(3\)](#) Any review should be documented to identify:

- when the review was undertaken
- what it involved
- the outcome (eg changes in conditions)
- who undertook the review.

Persons reviewing asbestos registers

108. Any person who reviews the asbestos register or employer's asbestos register needs to have the requisite knowledge, skills and experience to do so. The task should include locating the asbestos listed in the register, determining its condition and whether there is any risk associated with the presence of asbestos. Previous registers and records related to asbestos removal jobs, such as clearance certificates (if available), should also be reviewed to enable a comprehensive review.

A **clearance certificate** is a written statement that an inspection by an independent person has found that there is no visible asbestos residue remaining in an area where Class A or Class B asbestos removal work was performed or in the immediate surrounding area.

For further information about clearance certificates see page 102 of WorkSafe's *Removing asbestos in workplaces compliance code* (2018).

109. An in-house person who has been provided with appropriate instruction and training may be able to perform a walkthrough of the workplace to identify changes related to the asbestos and make necessary changes in the asbestos register.

Keeping a copy of the asbestos register

The person with management or control of the workplace

110. The person with management or control of a workplace needs to keep the current asbestos register for that workplace. Old registers and clearance certificates should be retained as they can assist in ensuring that a record is kept of the asbestos that has been removed from the workplace.
111. A person who manages or controls a workplace who intends to relinquish that management or control must provide a copy of the asbestos register to the person, if any, assuming management or control.
[OHS Regulations r230](#)

The employer

112. Any employer who is relinquishing management or control of plant with asbestos-containing parts needs to provide information – including the employer's asbestos register – to any new employer who will have management or control of the plant.

Indicating the presence of asbestos

113. Once asbestos has been identified in the workplace, its presence and location must be clearly indicated.
OHS Regulations r226(6)(a), r233(6)(a)
This includes inaccessible areas that are assumed to contain asbestos.
114. If reasonably practicable, the presence and location of asbestos must be indicated by labelling.
OHS Regulations r226(6)(b), r233(6)(b)
115. The location of any labels needs to be consistent with the results of asbestos identification recorded in the asbestos register or employer's asbestos register. For more information see 'Asbestos register' on page 30.
116. Labelling methods may vary depending on the location and type of asbestos that is present. Direct labelling is recommended; however, where this is not reasonably practicable, labels should be situated as close as possible to ACM or areas containing asbestos, for example:
 - a room with asbestos containing vinyl floor tiles may have labels with an arrow pointing down placed on the skirting boards on all four walls
 - a ceiling space that contains asbestos lagged steam pipes in good condition may have a label placed at the access door/hatch
 - an AC roof may have labels placed at access points to the roof.
117. Colour coded labelling may also be used to indicate the presence and location of asbestos. This method is less effective than direct labelling as the presence and meaning of the coloured labels and what action should be taken if labels are encountered needs to be communicated with employees and independent contractors.
118. Placing signs at the entrances of workplaces, buildings and rooms may also be used to indicate the presence and location of asbestos, but is less effective than direct labelling. If this method is used, signs should be placed at every entrance and also indicate that prior to any work being undertaken, the asbestos register should be referred to for the specific location and condition of asbestos and appropriate controls be implemented.
119. Where labelling is not reasonably practicable, a system of work to indicate the presence and location of asbestos needs to be provided, maintained and communicated to employees and independent contractors. For example, indicating the presence and location of asbestos on site plans, making them accessible to all employees and contractors, ensuring such plans are consulted prior to any work at the workplace, and ensuring employees and contractors are aware of the presence, meaning and purpose of the plans.

Indicating the presence of asbestos

120. Where direct labelling is not used, particular attention needs to be given to identifying the presence and location of asbestos to contractors, such as plumbers, electricians and carpenters, before they commence work. This may be achieved by implementing a permit-to-work system that ensures contractors are made aware of the presence and location of asbestos before they commence work.
121. Where there is material that does not contain asbestos but could be mistaken for asbestos, it may save time, confusion and money if its presence and location is identified and labelled as not containing asbestos.
122. See Appendix F for examples of signs and labels used to indicate the presence of asbestos in the workplace.
123. For further information about labelling asbestos go to **[worksafe.vic.gov.au](https://www.worksafe.vic.gov.au)**.

❖ Controlling risks to health associated with the presence of asbestos

Deciding if there is a risk to health that needs controlling

124. Employers must consult with employees when identifying or assessing hazards or risks to health or safety at the workplace (including the risk of exposure to airborne asbestos fibres) (see 'Consultation' on page 5). OHS Act s35 When determining if there is a risk of exposure to airborne asbestos fibres, consider whether:

- ACM is in poor condition
- ACM is likely to sustain damage or deterioration
- asbestos is likely to be damaged or disturbed due to activities carried out in the workplace (eg routine and maintenance activities), or
- asbestos is in an area where employees are exposed to the material.

125. If ACM is in good condition and left undisturbed, it is unlikely that asbestos fibres will become airborne. Where the risk of exposure to airborne asbestos fibres is low, it is usually safer to leave asbestos fixed or installed and review its condition over time. However, if ACM has deteriorated, been disturbed, or if ACD is present, the risk of exposure to airborne asbestos fibres is increased.

126. The type of material which binds asbestos fibres will influence the likelihood of asbestos fibres becoming airborne. For example, a loosely bound sprayed (or limpet) coating is more likely to release airborne asbestos fibres when disturbed than AC sheeting in which fibres are firmly bound.

127. The following list ranks the likelihood of asbestos fibres becoming airborne if different types of asbestos have deteriorated or are disturbed. The potential risk of exposure to airborne asbestos fibres is greater for items higher up the list, but any of the types of asbestos listed can produce airborne asbestos fibres if they have deteriorated or are disturbed.

Higher likelihood of airborne asbestos fibres

Sprayed (limpet) coatings/loose fill ACD (including dust left in place after inadequate past asbestos removal)*

Lagging and packings (that are not enclosed)

Asbestos insulating board

Millboard and paper

Rope and gaskets

AC products

Decorative paints and plasters

Floor tiles, mastic and bitumen-based water proofing

Lower likelihood of airborne asbestos fibres

***Note:** Ranking is subject to the likely amount of asbestos present in the ACD.

128. A visual inspection of asbestos, its location and an understanding of the activities carried out at the workplace may assist in determining the risk of exposure to airborne asbestos fibres.

Controlling risks to health associated with the presence of asbestos

129. Routine work activities (including maintenance) plus unusual and infrequent activities (such as emergency activities) should be considered. Also the proximity of asbestos to where employees work should be considered as this can affect the risk of exposure to airborne asbestos fibres.

Examples of activities that could pose a risk to health

- Forklifts driving adjacent to AC sheet walls may damage these sheets from accidental impacts during the course of work.
- Plumbers working on a long pipe that does not have asbestos insulation where the work is being done may cause disturbance to asbestos-containing insulation on the pipe some metres away.
- Electricians working in a ceiling space sprayed with friable ACM may disturb this material.
- Acid fumes from an acid bath located next to an AC wall and below an AC roof may cause deterioration of the ACM over time.

Controlling risk using the hierarchy of control

130. A person who manages or controls a workplace and an employer:
- must, so far as is reasonably practicable, **eliminate** any risk associated with the presence of asbestos that is under their management or control by removing the asbestos
 - if it is not reasonably practicable to remove the asbestos, they must **reduce** the risk associated with the presence of asbestos so far as is reasonably practicable by **enclosing** the asbestos
 - if they have enclosed the asbestos, so far as is reasonably practicable, and a risk remains, they must **reduce** the risk associated with the presence of asbestos so far as is reasonably practicable by **sealing** the asbestos. [OHS Regulations r231\(1\), r238\(1\)](#)
131. Careful planning and design of proposed risk control measures is critical. Consideration should be given to engaging a person with the requisite knowledge, skills and experience, such as an occupational hygienist with experience in asbestos management, to assist in the planning and design of risk control measures.
132. Employers must consult with employees when making decisions about risk control measures at a workplace (see 'Consultation' on page 5).

Controlling risks to health associated with the presence of asbestos

Eliminating risk by removing the asbestos

133. A person who manages or controls a workplace or an employer, must, so far as is reasonably practicable, eliminate any risk associated with the presence of asbestos that is under their management or control by removing the asbestos.
OHS Regulations r231(1), r238(1)
134. The ultimate goal is for workplaces to be free of asbestos. Where damaged or deteriorating ACM is present, it needs to, so far as is reasonably practicable, be removed. Where ACM such as gaskets and seals are present, they should be removed and replaced during maintenance activities regardless of their condition to prevent exposure to airborne asbestos fibres. The replacement of any part of plant with ACM is prohibited (for example, any replacement gaskets or seals must not contain asbestos)
OHS Regulations r224.

Note: In some cases, whilst elimination may not seem reasonably practicable, it may be that the risk of exposure to airborne asbestos fibres to people enclosing or sealing asbestos is so significant that removal by an asbestos removal licence holder needs to be considered. The person with management or control of the workplace and employer needs to consider the ongoing maintenance requirements associated with enclosure or sealing compared to removal when considering whether elimination is reasonably practicable in the circumstances.

Examples of where elimination of asbestos may be reasonably practicable

- The friable asbestos lagging on pipes where the outer casing has deteriorated, has been damaged and is likely to further deteriorate. Debris is located on the ground beneath it and employees are required to work on or near it. Removal should be considered as a priority and would likely be reasonably practicable.
 - AC sheets around a factory roller door entrance have been damaged and are deteriorating and posing a risk to health – the damage may have been due to forklifts or other vehicles over time knocking against them and this may continue to occur. Removal should be considered as a priority and would likely be reasonably practicable.
135. Asbestos removal work must be performed in accordance with 'Division 7 – Removal of asbestos' in 'Part 4.4 – Asbestos' of the OHS Regulations. For more information about asbestos removal work (including the removal of gaskets) see page 15 of WorkSafe's *Removing asbestos in workplaces compliance code* (2018).

Reducing risk by enclosing the asbestos

136. If it is not reasonably practicable to remove asbestos, the person who manages or control the workplace and the employer must reduce the risk associated with its presence must, so far as is reasonably practicable, by enclosing the asbestos.
OHS Regulations r231(2), r238(2)

Controlling risks to health associated with the presence of asbestos

137. Enclosing asbestos means placing a fixed barrier between it and the surrounding area so people are not at risk of exposure to airborne asbestos fibres. However, the activity of enclosing the asbestos may present a risk to health for the person conducting the work if the asbestos is disturbed and airborne asbestos fibres are released.
138. Enclosing asbestos is an asbestos-related activity and must be performed in accordance with 'Division 8 – Activities involving asbestos' in Part 4.4 of the OHS Regulations. For more information see 'Identifying regulated asbestos-related activities' on page 57.

Case study: Enclosing asbestos as a risk control measure

A large warehouse used for temporarily storing quantities of grain and stockfeed has walls made from a variety of materials including AC sheet. Apart from the driver of a large front-end loader that is briefly driven into the warehouse to load or unload the feed, there are no other employees who work in the warehouse. The employer with management or control of the warehouse conducts the regular inspection of the AC sheet and identifies that it is in good condition and that no risk to health currently exists. However, it is decided that there is a chance that the sheets may be damaged as a result of accidental impact from the front end loader and, a risk to health may occur if asbestos fibres become airborne. Therefore, the employer decides to assess options for controlling the risk.

The most effective form of risk control in this case would be to remove the AC sheets. However, due to a range of issues – good condition of the AC sheet, the low risk it posed to health, cost, warehouse downtime, loss of productivity – the person with management or control decides not to remove the AC sheet because it is not reasonably practicable to do so and instead decides to enclose it to prevent future accidental damage.

A solid false wall is constructed to enclose the AC sheet and bollards are erected in front of the new wall to prevent collisions that may occur when the front loader is operating inside the warehouse.

The employer continues to revise their asbestos register to ensure it is kept current (see 'Reviewing the asbestos register' on page 33).

Controlling risks to health associated with the presence of asbestos

Reducing risk by sealing the asbestos

139. If the person who manages or controls the workplace or the employer has enclosed the asbestos, so far as is reasonably practicable, and a risk remains, they must reduce the risk associated with the presence of asbestos so far as is reasonably practicable by sealing the asbestos. OHS Regulations r231(3), r238(3)
140. Sealing means covering the surface of the ACM with a protective coating to prevent the release of airborne asbestos fibres.
141. Sealing ACM is the least effective method for controlling the release of airborne asbestos fibres as the coating used may deteriorate over time, especially if it is exposed to chemicals, extreme temperatures (hot or cold), wet or dry conditions or physical damage (eg impacts, drilling or sanding). Once it has deteriorated (for example, where sealing has eroded), sealing is unlikely to effectively control the risk of asbestos fibres becoming airborne. Therefore, sealing should only be considered an interim risk control measure until a more effective control measure, such as removing or enclosing the ACM, can be implemented.
142. Epoxy-based paints are appropriate for sealing ACM as they typically have greater durability and strength than other paints. It is important to select a coating that is appropriate for the material to be sealed and, if applicable, to ensure that the coating has the necessary fire resistance, thermal insulation or UV properties for it to be an effective control measure.
143. The use of sealants of a different colour to the ACM is recommended to assist in identifying its condition over time and when conducting reviews of the asbestos register. A date-stamped photograph of the sealed surface may also assist in recording its condition.
144. The activity of sealing the asbestos may present a risk to health for the person conducting the work if the asbestos is disturbed and airborne asbestos fibres are released. Sealing needs to be carried out on materials that are in good condition. If the material is significantly weathered, damaged or broken and creates a risk, the material should be removed and replaced with a material that does not contain asbestos.
145. Before applying sealant, a Dust Class H vacuum cleaner should be used to capture any loose dust or debris from the surface of the ACM to ensure good adhesion of the sealant. When applying the sealant, an airless spray at low pressure needs to be used to avoid generating high levels of airborne asbestos fibres. An airless sprayer at low pressure is preferred to rollers or brushes on exposed (or unsealed) asbestos as rollers and brushes may cause abrasion/damage and result in airborne asbestos fibres being released from the surface of the material.
146. Sealing asbestos is an asbestos-related activity and must be performed in accordance with 'Division 8 – Activities involving asbestos' in Part 4.4 of the OHS Regulations. For more information see 'Identifying regulated asbestos-related activities' on page 57. For more information on sealing asbestos see 'Appendix J – Sealing asbestos cement sheeting' on page 98.

Controlling risks to health associated with the presence of asbestos

Examples of sealing asbestos as an interim risk control measure

The extensive water pipe system in a large industrial workplace consists of AC piping and conduits. Some of the pipes are located underground, some within inaccessible areas such as walls and others run above ground throughout the workplace and are exposed. Connected to some of these pipes are control valves that are occasionally accessed.

Over time, as some of the AC pipes have deteriorated or been damaged and where reasonably practicable to do so, the employer has arranged for the removal of sections of AC pipe to reduce the risk. Where a risk still remained, the employer has enclosed the pipes so far as is reasonably practicable to reduce the risk further.

Where control valves are connected and the AC pipe was in good condition, the employer determined that it was not practicable to enclose the asbestos because the control valves are occasionally accessed. Therefore, the employer decided to seal the surface of the AC pipes near control valves with an epoxy-based paint to protect the material from deterioration and reduce the risk of airborne asbestos fibres. This risk control measure is an interim risk control measure.

The employer continues to revise their asbestos register to ensure it is kept current (see 'Reviewing the asbestos register' on page 33).

Proper installation and maintenance of risk control measures

147. A person who manages or controls a work and an employer must ensure that risk control measures are properly installed (if applicable), used and maintained. [OHS Regulations r18](#)

Maintaining a risk control measure may include providing a system for regular inspection and review to ensure that the risk control measure is still in place, performing its function and has not deteriorated, been damaged, or removed.

148. Where a risk control measure other than removal is implemented, it needs to be installed by a person with the requisite knowledge, skills and experience of the risks of exposure to asbestos fibres.

Review of risk control measures

149. A person who manages or controls a workplace must review and, if necessary, revise measures implemented to control risks associated with the presence of asbestos:
- before any change is made to the workplace or a building, structure, ship or plant at the workplace or a system of work that is likely to damage or disturb any asbestos
 - after any incident occurs to which Part 5 of the OHS Act applies that involves the presence of asbestos, or
 - if, for any other reason, the risk control measures do not adequately control the risks. [OHS Regulations r232](#)

Controlling risks to health associated with the presence of asbestos

150. An employer must review and, if necessary, revise measures implemented to control risks associated with the presence of asbestos:
- before any change is made to the workplace or a building, structure, ship or plant at the workplace or a system of work that is likely to damage or disturb any asbestos
 - after any incident occurs to which Part 5 of the OHS Act applies that involves the presence of asbestos
 - if, for any other reason, the risk control measures do not adequately control the risk, or
 - after receiving a request from an HSR. [OHS Regulations r239\(1\)](#)
151. An HSR may request a review if they believe on reasonable grounds that any of the circumstances outlined in paragraph 150 exist or the employer has failed to properly review the risk control measures or to take account of any of the above circumstances in conducting a review of, or revising, the risk control measures. [OHS Regulations r239\(2\)](#)
152. The costs of implementing risk control measures can be high and the requirements for ongoing maintenance onerous, meaning the removal of asbestos by an asbestos removal licence holder may be a more viable option.

Information, instruction, training and supervision

153. Employers must provide such information, instruction, training or supervision to employees of the employer (including independent contractors and any employees of the independent contractor) as is necessary to enable those persons to perform their work in a way that is safe and without risks to health. [OHS Act s21\(2\)\(e\)](#) and [s21\(3\)](#) Information, instruction and training needs to include:
- the hazards associated with asbestos and the potential risk to health based on the particular circumstances at the workplace
 - risk control measures (including safety procedures) to be used
 - the reasons for the risk control measures
 - how the risk control measures are to be used and maintained
 - the method of indicating the presence and location of asbestos including any labelling system
 - why medical examinations may be necessary and what is involved
 - the right of employees to have access to the asbestos register.

Demolition and refurbishment

154. Where demolition or refurbishment work is carried out at a workplace on a building, structure, ship or plant where asbestos is present, or elsewhere at the workplace where asbestos has been identified; there are duties on the person who has management or control of the workplace and any employer who has management or control of asbestos (for example, ACM that is fixed to or installed in any plant under the management or control of the employer).
OHS Regulations r240(1)

155. There are also duties that apply to employers and self-employed persons who are to perform the demolition or refurbishment work.

Definition of the terms ‘demolition’ and ‘refurbishment’

Demolition

156. For the specific purpose of this Code and in relation to ‘Part 4.4 – Asbestos’ of the OHS Regulations only, **demolition** is the complete dismantling or the complete or partial destruction of a building, structure, ship or plant such that it cannot be used in that form again.

Examples of demolition:

- Complete dismantling of a decommissioned industrial plant, such as a boiler.
- Total destruction of a building or part of a building.

Refurbishment

157. For the specific purpose of this Code and in relation to ‘Part 4.4 – Asbestos’ of the OHS Regulations only, **refurbishment** may involve the partial dismantling of a building, structure, ship or plant for the purpose of renovating or rebuilding.

Examples of refurbishment include the partial dismantling of:

- a boiler for the purpose of cleaning and repairing
- large plant to access and remove asbestos-containing gaskets for the purpose of replacement with non-asbestos-containing gaskets
- a building by removing sections of an AC roof in stages for the purpose of replacing or rebuilding the roof
- part of a building for the purpose of renovation.

Definition of the terms ‘minor or routine maintenance work’ or ‘work of a minor nature’

158. Demolition and refurbishment work **does not** include minor or routine maintenance work or other work of a minor nature.
OHS Regulations r240(2)

Demolition and refurbishment

Minor or routine maintenance work

159. For the specific purpose of this Code and in relation to 'Part 4.4 – Asbestos' of the OHS Regulations only, **minor or routine maintenance work** includes work that is small scale, often short in duration and may be unscheduled. This work may require the partial dismantling of a structure or plant.

Examples of minor or routine maintenance work including partial dismantling of:

- a piece of plant to remove an asbestos-containing gasket
- a passenger lift or press machine to remove an asbestos-containing brake component
- a piece of plant for the purpose of cleaning or repair.

Work of a minor nature

160. For the specific purpose of this Code and in relation to 'Part 4.4 – Asbestos' of the OHS Regulations only, **work of a minor nature** includes small tasks that are of short duration, such as cutting a small hole or hand drilling up to a few holes into AC sheet. Work of a minor nature is not routine or regular such as planned maintenance. It is incidental work that can be done quickly and safely with minimal risk control measures to ensure safety.

Examples of work of a minor nature:

- Cutting a small hole into an asbestos-containing eave to install a cable.
- Removal of an asbestos-containing vinyl tile to install a plumbing fixture.
- Hand drilling a few holes into AC sheet to attach a fitting.

Duties of employers or self-employed persons performing minor or routine maintenance work or work of a minor nature

161. Where minor maintenance work or work of a minor nature is carried out at a workplace, the requirements of 'Division 6 – Demolition and refurbishment where asbestos is present' **do not** apply. Depending on the nature of the work being performed, duties under 'Divisions 7 – Removal of asbestos', 'Division 8 – Activities involving asbestos', or other Parts of the OHS Regulations may apply (see Figure 1).

Demolition and refurbishment

Figure 1: Duties of employers or self-employed persons performing minor or routine maintenance work or work of a minor nature

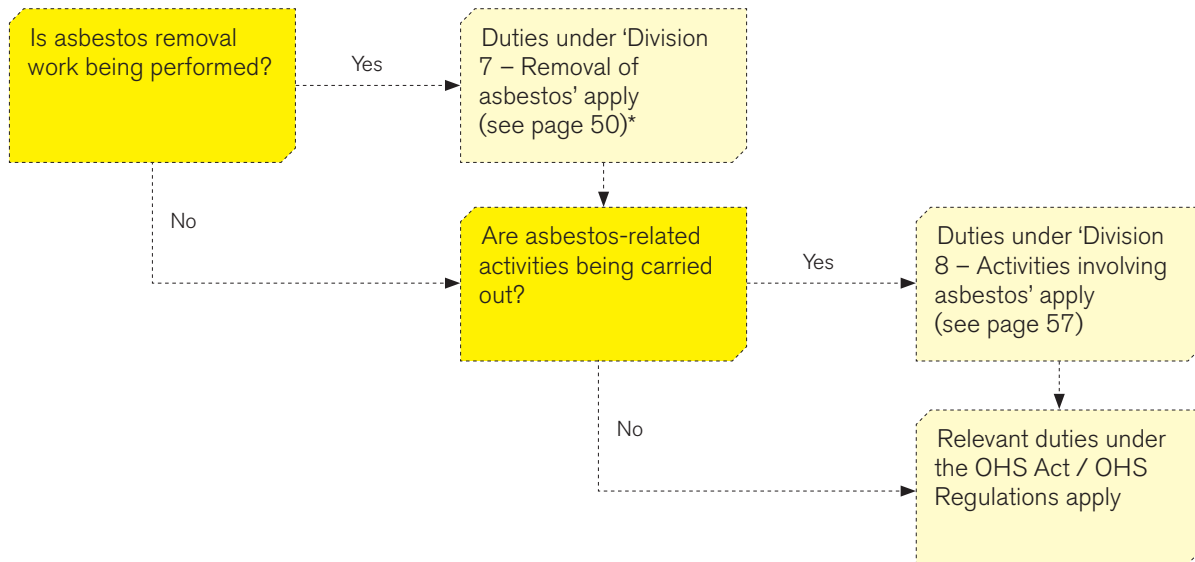

***Note:** for more information on asbestos removal work see WorkSafe's *Removing asbestos in workplaces compliance code* (2018).

Example 1:

An employer or self-employed person engaged to dismantle a piece of plant in order to remove an asbestos-containing gasket must perform such work in accordance with 'Division 7 – Removal of asbestos' (see page 50). This includes obtaining any relevant asbestos register before performing such work at a workplace.

Example 2:

An employer or self-employed person engaged to resecure an enclosure used to control the risk associated with ACM that is in good condition must perform such work in accordance with 'Division 8 – Activities involving asbestos' (see page 57). This includes obtaining any relevant asbestos register before performing such work at a workplace.

Review of the asbestos register prior to demolition or refurbishment

162. Before demolition or refurbishment commences at a workplace, the person who manages or controls the workplace must review the asbestos register and revise the asbestos register if it is inadequate having regard to the proposed demolition or refurbishment work.
OHS Regulations r241(1)

The asbestos register may be inadequate if it identifies areas that are inaccessible, that are likely to contain asbestos, and those areas will be accessible as a result of the proposed demolition or refurbishment work.

163. The person who manages or controls a workplace must provide the employer or self-employed person who is to perform demolition or refurbishment work at the workplace with a copy of the asbestos register, including any revisions made.
OHS Regulations r241(2)
164. Before demolition or refurbishment work commences at a workplace, an employer who has management or control of asbestos, including ACM that is fixed to or installed in any plant under the management or control of the employer, must review the employer's asbestos register and revise the employer's asbestos register if it is inadequate, having regard to the proposed demolition or refurbishment work. The employer must provide the employer or self-employed person who is to perform the demolition or refurbishment work with a copy of the employer's asbestos register, including any revisions made.
OHS Regulations r242
165. When reviewing the asbestos register, the person with management or control of the workplace or employer with management or control of asbestos should consider the following questions:
- Where is the asbestos located in relation to the proposed demolition or refurbishment?
 - Are there any inaccessible areas that are likely to contain asbestos and will be disturbed as a result of the demolition or refurbishment?
 - What is the type and condition of the asbestos?
 - What is the quantity of asbestos?
 - What is the method of demolition or refurbishment and how will it affect the asbestos?
 - If the asbestos is likely to be damaged or disturbed during the demolition or refurbishment, can it be removed safely before work commences and how can this be done?
166. The employer or self-employed person performing demolition or refurbishment work in relation to a building, structure, ship or plant at a workplace must obtain:
- a copy of the asbestos register, including any revisions made, from the person who has management or control of the workplace
 - a copy of the employer's asbestos register, including any revisions made, from the employer who has management or control of asbestos, including ACM that is fixed or installed in any plant under the management or control of the employer.
OHS Regulations r243
167. For more information on demolition or refurbishment work and asbestos registers go to **[worksafe.vic.gov.au](https://www.worksafe.vic.gov.au)**.

Duties that apply if no asbestos register exists for the workplace

Duty on the employer or self-employed person performing demolition or refurbishment

168. In some cases there may not be an asbestos register or employer's asbestos register in relation to the proposed demolition or refurbishment.
169. This may be because:
- asbestos has not been identified
 - the person with management or control of the workplace or employer has breached their duty to have an asbestos register or employer's asbestos register, or
 - demolition or refurbishment work is being performed at domestic premises.
170. The employer or self-employed person performing the demolition or refurbishment work must not commence that work until they have determined whether asbestos is present in the building, structure, ship or plant to be demolished or refurbished. [OHS Regulations r245\(2\)](#)
171. If there is uncertainty (based on reasonable grounds) as to whether asbestos is present in a building, structure, ship or plant to be demolished or refurbished, or if there are inaccessible areas that are likely to contain asbestos, the employer or self-employed person performing the demolition or refurbishment work must:
- assume asbestos is present, or
 - arrange for analysis of a sample to be undertaken. [OHS Regulations r245\(3\)](#)
- Note:** If samples are taken for the purpose of identifying if asbestos is present, it is important that representative samples are taken.
172. If asbestos is assumed to be present, it is taken to be identified for the purposes of 'Division 6 – Demolition and refurbishment where asbestos is present' in Part 4.4 – Asbestos' of the OHS Regulations. [OHS Regulations r245\(4\)](#)
173. If the employer or self-employed person performing demolition or refurbishment work has determined (by either of the methods in paragraph 171) that asbestos is present in a building, structure, ship or plant to be demolished or refurbished, they must:
- inform the person who has management or control of the workplace that asbestos is present in the building, structure, ship or plant, and
 - in the case of plant under the management or control of an employer at the workplace, inform the employer that asbestos is present in the plant. [OHS Regulations r245\(5\)](#)

Demolition and refurbishment

Identification and removal of asbestos before demolition or refurbishment

Workplaces

174. A person who manages or controls a workplace or plant that forms part of a workplace must identify asbestos under their management or control that is likely to be disturbed by proposed demolition or refurbishment work and:
- if the proposed work is refurbishment work ensure, so far as is reasonably practicable, that the asbestos is removed; or
 - if the proposed work is demolition work ensure, so far as is reasonably practicable, that the asbestos is removed **before** the demolition work is commenced. [OHS Regulations r244\(1\)](#)
175. An employer at a workplace must identify asbestos under their management or control, including ACM that is fixed or installed in any plant, that is likely to be disturbed by proposed demolition or refurbishment work and:
- if the proposed work is refurbishment work ensure, so far as is reasonably practicable, that the asbestos is removed; or
 - if the proposed work is demolition work ensure, so far as is reasonably practicable, that the asbestos is removed **before** the demolition work is commenced. [OHS Regulations r244\(2\)](#)
176. These duties do not apply to demolition work in an emergency (see paragraphs 184 to 194) or to domestic premises (see paragraphs 178 to 180). [OHS Regulations r244\(4\)](#)
177. Partial demolition of a building, structure, ship or plant is permitted to gain access to asbestos. [OHS Regulations r244\(3\)](#) For example, part of a wall may be demolished to remove asbestos in the wall cavity.

Domestic premises

178. When an employer or self-employed person has been engaged to perform demolition or refurbishment work at domestic premises, it becomes the workplace of that person.
179. An employer or self-employed person performing demolition or refurbishment work on domestic premises must identify asbestos under their management or control that is likely to be disturbed by the proposed demolition or refurbishment work and:
- if the proposed work is refurbishment work ensure, so far as is reasonably practicable, that the asbestos is removed; or
 - if the proposed work is demolition work ensure, so far as is reasonably practicable, that the asbestos is removed **before** demolition work is commenced. [OHS Regulations r244\(5\)](#)
180. Partial demolition of domestic premises is permitted to gain access to asbestos. [OHS Regulations r244\(6\)](#) For example, part of a wall may be demolished to remove asbestos in a wall cavity.

The treatment of demolition and refurbishment work differs, as it is not always practical to remove asbestos that is likely to be disturbed before refurbishment work commences. Asbestos that is likely to be disturbed must, so far as is reasonably practicable, be removed but this may occur either before or during refurbishment work.

For example, removing an entire AC sheet roof can expose a building to the weather and it may be more practical to remove the roof in stages during refurbishment work.

Asbestos removal work

181. A person who manages or controls a workplace or plant that forms part of a workplace, and an employer at a workplace who has management or control of asbestos, must ensure that asbestos removal work is performed by an asbestos removal licence holder or by a person who is permitted to perform limited asbestos removal work (see Figure 2).
OHS Regulations r246
182. An employer or self-employed person performing demolition or refurbishment work on domestic premises must ensure that asbestos removal work is performed by an asbestos removal licence holder or by a person who is permitted to perform limited asbestos removal work.
OHS Regulations r246
183. Asbestos removal work must be performed in accordance with 'Division 7 – Removal of asbestos' in 'Part 4.4 – Asbestos' of the OHS Regulations. For more information about asbestos removal work see page 15 of WorkSafe's *Removing asbestos in workplaces compliance code* (2018).

Demolition and refurbishment

Figure 2: Who can perform asbestos removal work?

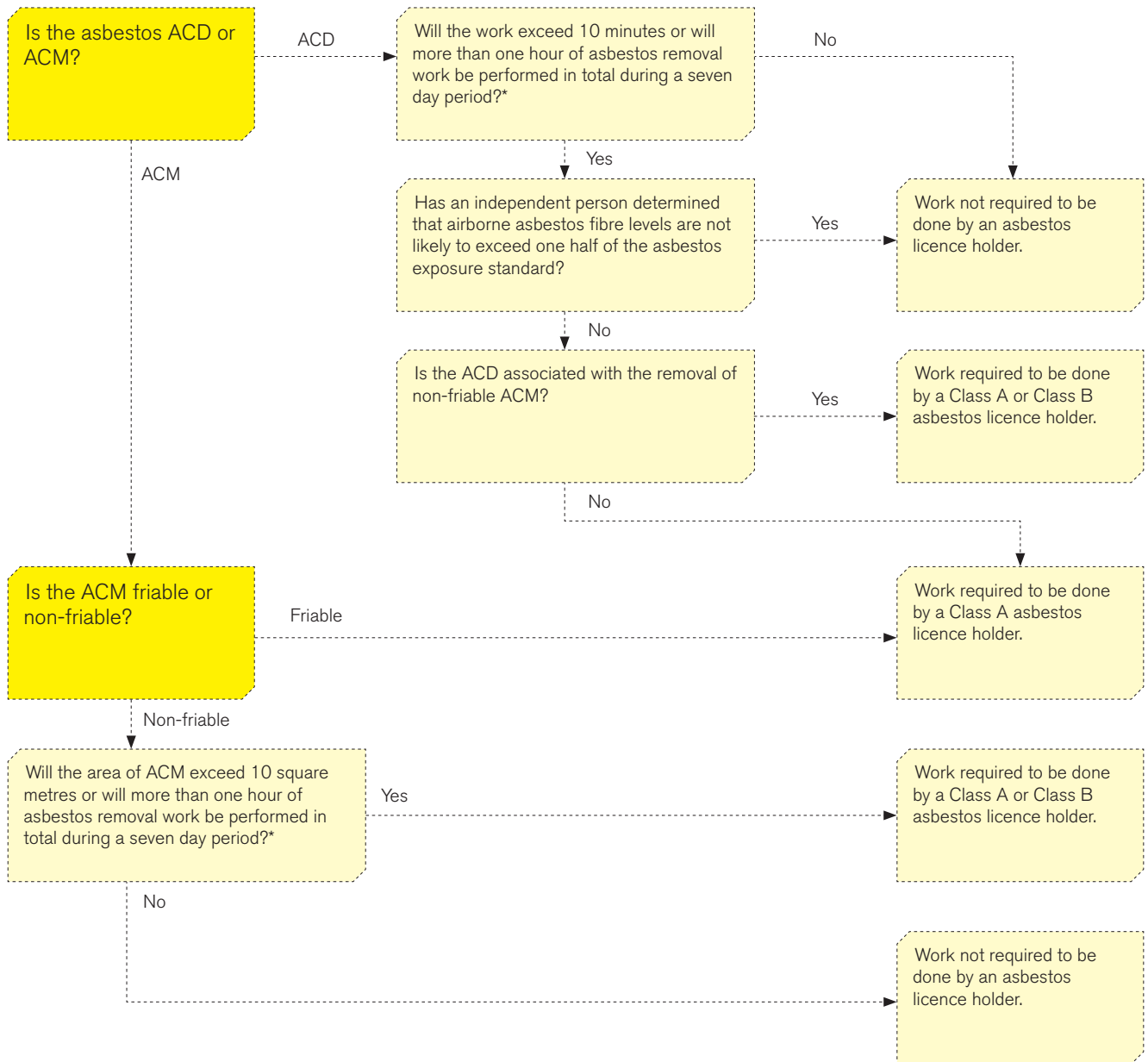

***Note:** for the purposes of determining the time spent performing asbestos removal work, the total cumulative time that all employees, independent contractors, and self-employed persons will spend performing such work is to be included.

Workplace emergency where asbestos is present

Defining an emergency

184. An emergency exists if a building (or part of a building) or structure is structurally unsound or in danger of imminent collapse as determined:
- by an emergency order issued under the *Building Act 1993*, or
 - in a report by a structural engineer. [OHS Regulations r240\(3\)](#)
185. An emergency is likely to include the situation where a building (or part of a building) is in danger of collapse due to, for example, a fire or explosion. If asbestos is present in this situation there is an added risk to health and safety due to the potential for asbestos fibres to become airborne.

Duties in the case of an emergency

186. If an emergency occurs at a workplace where asbestos was present in a building, structure, ship or plant immediately before the emergency occurred, the person who manages or controls the workplace must:
- consider the asbestos register
 - before demolition occurs, document a procedure that will reduce the risk of exposure of employees and persons in the vicinity of the demolition site to asbestos to below the asbestos exposure standard so far as is reasonably practicable, and
 - notify WorkSafe, in writing, of their contact details and of the location of the emergency immediately after the emergency is known to that person and before the commencement of demolition work. [OHS Regulations r247\(1\), r248\(1\)](#)
187. If an emergency occurs at domestic premises where asbestos was present in a building, structure, ship or plant immediately before the emergency occurred, an employer or self-employed persons performing demolition work at the premises must:
- before demolition, document a procedure that will reduce the risk of exposure of employees and persons in the vicinity of the demolition site to asbestos to below the asbestos exposure standard so far as is reasonably practicable, and
 - notify WorkSafe, in writing, of their contact details and of the location of the emergency immediately after the emergency is known to that person and before the commencement of demolition work. [OHS Regulations r247\(4\), r248\(2\)](#)
- Note:** When drafting the procedure, the items listed in 'Appendix Q – Information required to be included in an asbestos control plan' should be considered. The demolition contractor and asbestos removal licence holder engaged to do the work also need to be consulted when drafting the procedure.
188. If an emergency occurs action may be required before complying with the duties to consider the asbestos register, document a procedure, and notify WorkSafe in writing. In taking such action, care should be taken to minimise the risk from any potential exposure to airborne asbestos fibres.
189. The person who has, to any extent, the management or control of the workplace must ensure, so far as is reasonably practicable, that the workplace and the means of entering and leaving it are safe and without risks to health. [OHS Act s26](#)

Demolition and refurbishment

190. In the case of an emergency requiring asbestos removal and/or demolition, the employer or self-employed person performing the work has duties in both 'Part 4.4 – Asbestos' and 'Part 5.1 – Construction' of the OHS Regulations to record how the work will be done safely.
191. High-risk construction work includes construction work involving demolition or the removal or likely disturbance of asbestos. **OHS Regulations r322(c)(d)** An employer or self-employed person must not perform high-risk construction work if there is a risk to the health or safety of any person arising from the work, unless a safe work method statement (SWMS) is prepared for the work before the work commences and the work is performed in accordance with the statement. **OHS Regulations r327(1)**
192. For high risk construction work involving the removal or likely disturbance of asbestos, if there is a risk to the health or safety of any person arising from the work, preparation of an asbestos control plan in accordance with 'Part 4.4 – Asbestos' of the OHS Regulations it is taken to be equivalent to the preparation of a SWMS. **OHS Regulations r327(3)(a)** Therefore a SWMS does not need to be prepared where an asbestos control plan is prepared in relation to Class A or Class B asbestos removal work.
193. However, if there is construction work other than demolition or the removal or likely disturbance of asbestos that falls within the meaning of high-risk construction work, a SWMS addressing those other activities must be prepared. A reference to the asbestos control plan should be included in the SWMS.

Asbestos removal work in an emergency

194. A person engaged for the purpose of asbestos removal work as part of an emergency must comply with 'Division 7 – Removal of asbestos' of 'Part 4.4 – Asbestos' in the OHS Regulations. **OHS Regulations r247(3)** For more information about asbestos removal work see page 15 of WorkSafe's *Removing asbestos in workplaces compliance code* (2018).

Asbestos management plan

195. An asbestos management plan is a documented outline of how asbestos in the workplace will be managed. While an asbestos management plan does not need to be prepared or maintained under the OHS Regulations, it is a beneficial tool for managing the risks associated with asbestos in the workplace. The plan should be clear and unambiguous and set out:
- what is going to be done
 - when it is going to be done
 - how it is going to be done
 - who is going to do it – consider appointing a contact person to manage and oversee any asbestos management issues.
196. The asbestos management plan should be kept at the workplace to ensure that it is accessible and include the following information:
- the current asbestos register or employer's asbestos register for the workplace
 - the method by which all relevant people (including independent contractors) will be consulted (for further information on consultation see 'Consultation' on page 5) and provided with information about the location, type and condition of asbestos and any risk to health
 - an outline of how asbestos risks will be controlled, including consideration of appropriate risk control measures
 - any clearance certificates relating to previous asbestos removal work
 - a timeline for action that sets out priorities based on the level of risk to health
 - the method by which the person with management and control of the workplace or employer will monitor the condition of 'in situ' asbestos
 - the method by which the person with management and control of the workplace or employer will monitor any risk control measures that are in place to ensure there is no risk to health
 - the responsibilities of all people involved and the sections of the plan they are responsible for
 - the information, instruction and training to be provided to employees at the workplace and how it will be provided
 - procedures for recording accidents, incidents or emergencies related to asbestos
 - air monitoring procedures
 - a timetable for reviewing and updating the asbestos management plan and asbestos register or employer's asbestos register.
197. The asbestos management plan should be reviewed when:
- there is a review of the asbestos register or employer's asbestos register
 - asbestos is removed, disturbed, sealed or enclosed
 - the plan is no longer adequate for managing asbestos at the workplace
 - an HSR requests a review if they reasonably believe that any of the matters listed above affect or may affect the health and safety of a member of their DWG and the asbestos management plan was not adequately reviewed.

Asbestos management plan

198. These reviews should critically reassess all asbestos management processes and their effectiveness in:
- preventing exposure to airborne asbestos fibres
 - controlling the work carried out by maintenance employees and contractors, highlighting the need for action to maintain or remove asbestos
 - raising awareness among employees
 - maintaining the accuracy of the asbestos register.
199. The flow chart in Figure 3 (page 56) outlines the general principles of an asbestos management plan.
200. For information about developing an asbestos management plan go to **worksafe.vic.gov.au**.

Asbestos management plan

Figure 3: General principles of an asbestos management plan

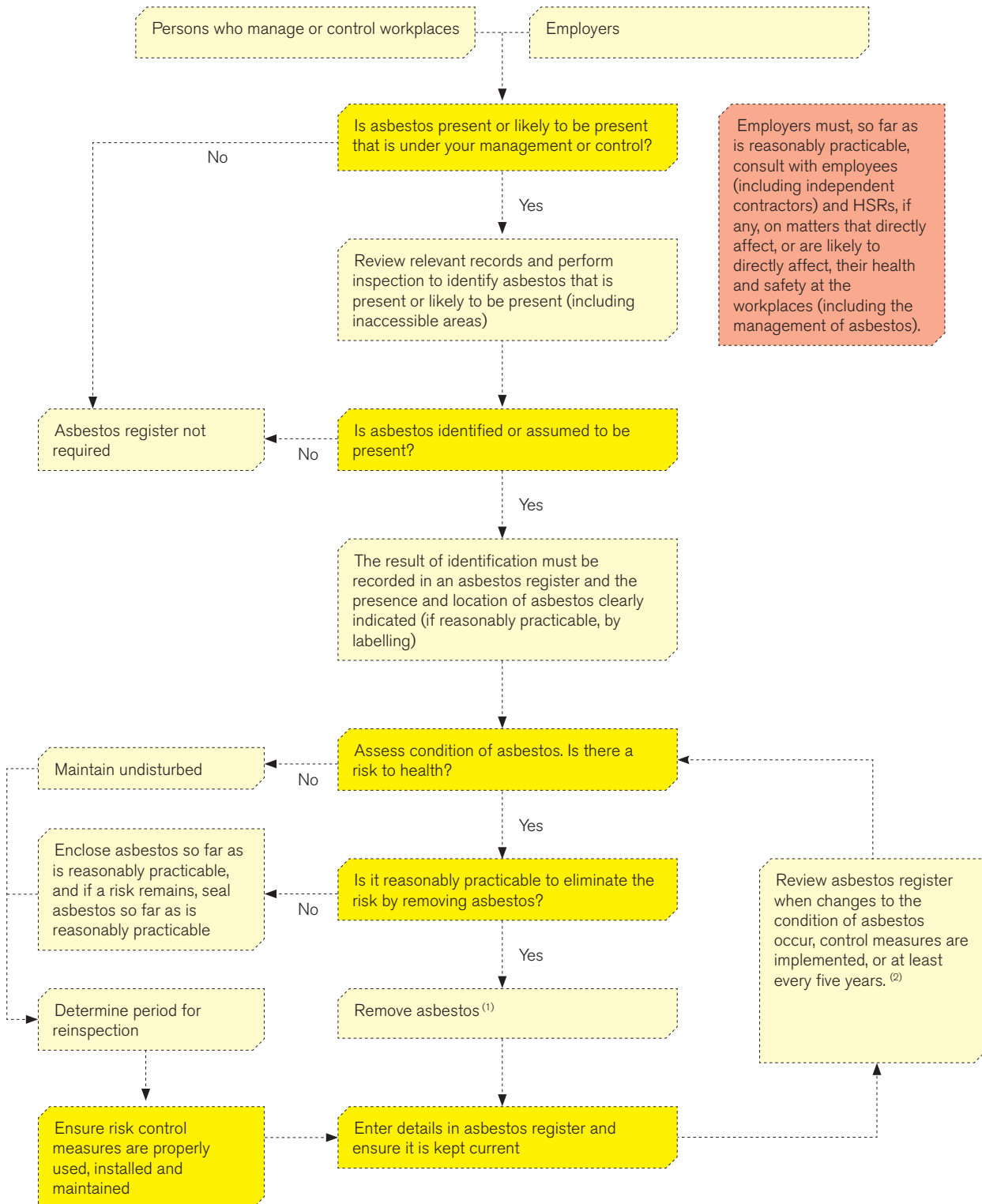

(1) It is recommended that asbestos removal clearance certificates and associated air monitoring (as applicable) be retained to provide evidence that asbestos removal has been satisfactorily completed.

(2) It is recommended that indication of the presence and location of asbestos (for example, labelling) be reviewed.

Asbestos-related activities

Identifying regulated asbestos-related activities

201. 'Division 8 – Activities involving asbestos' of 'Part 4.4 – Asbestos' in the OHS Regulations sets out the duties on employers where asbestos-related activities (other than asbestos removal work) are undertaken in their workplace.
202. An employer must identify whether an asbestos-related activity is being carried out at the employer's workplace. [OHS Regulations r303](#) For more information see 'Appendix G – Asbestos-related activities' on page 86.
203. If there is uncertainty (based on reasonable grounds) as to whether an activity is an asbestos-related activity, the employer must assume that asbestos is present (and treat the activity as an asbestos-related activity) or arrange for analysis of a sample to be undertaken. [OHS Regulations r304](#)

Note: If samples are taken for the purpose of identifying if asbestos is present, it is important that representative samples are taken.

204. If any of the following asbestos-related activities are carried out at an employer's workplace, the employer must obtain a copy of the asbestos register in relation to the activities or, if there are other employers at the workplace where the activities are carried out, a copy of the employer's asbestos register of each of those other employers: [OHS Regulations r305\(1\)](#)
- research involving asbestos
 - sampling or analysis involving suspected asbestos
 - the enclosing or sealing of asbestos
 - hand drilling and cutting of ACM
 - any other activity (other than asbestos removal work to which 'Division 7 – Removal of asbestos' applies) that is likely to produce airborne asbestos fibres in excess of one half of the asbestos exposure standard
 - any other activity determined by WorkSafe to be an asbestos-related activity. [OHS Regulations r305\(2\)](#)

Note: If WorkSafe makes a determination of an asbestos-related activity it will publish a notice in the Government Gazette and, as soon as reasonably possible, in a newspaper circulating generally throughout Victoria. For further information go to worksafe.vic.gov.au.

205. The duty to obtain an asbestos register does not apply if the asbestos-related activity will be carried out at a domestic premises and the person who commissioned the activity is the occupier of those premises. **OHS Regulations r305(3)** This is because there is no duty on the occupier to identify and record the results of an identification in an asbestos register. In this case, the employer who will carry out the asbestos-related activity must identify and control any risks to health arising from the activity.

Information, instruction, training, and supervision

206. Employers must provide such information, instruction, training or supervision to employees (including independent contractors and any employees of independent contractors) as is necessary to enable those persons to perform their work in a way that is safe and without risks to health. **OHS Act s21(2)(e)**

207. Information, instruction and training needs to be provided before employees commence an asbestos-related activity, particularly in relation to:

- the nature of the hazard
- the risks and health effects associated with exposure to airborne asbestos fibres including:
 - how asbestos can affect a person's health
 - the added dangers of smoking
- the need for, and proper use of, measures to control the risks including:
 - appropriate controls
 - what methods and equipment will do the job properly
 - how to choose, use, maintain clean and store personal protective clothing and RPE
 - decontaminating the work area, tools and equipment, and personal decontamination
 - asbestos waste disposal
 - emergency procedures
 - maintenance of risk controls.

208. An employer must make a record of any training provided in relation to carrying out asbestos-related activities and keep that record for so long as it is applicable. **OHS Regulations r319**

Information to job applicants

209. An employer must provide each applicant who applies for employment with the employer to carry out an asbestos-related activity with information about the nature of the hazard and the risks to health associated with exposure to airborne asbestos fibres.

OHS Regulations r318

Note: This duty does not apply to hand drilling and cutting of ACM or any other activity (other than asbestos removal work to which 'Division 7 – Removal of asbestos' applies) that is likely to produce airborne asbestos fibres in excess of one half of the asbestos exposure standard.

Employer's duty to control risks to health associated with asbestos-related activities

210. Asbestos fibres may be released and become airborne during an asbestos-related activity; this may present a risk to the health of employees and other people in the workplace.

211. An employer must ensure that, when carrying out an asbestos-related activity, the activity is carried out in a manner that, so far as is reasonably practicable, eliminates the release of airborne asbestos fibres.

OHS Regulations r306 An employer must also control any risk associated with an asbestos-related activity by implementing risk control measures according to the hierarchy of control outlined in paragraph 212 to 223. OHS Regulations r307 The employer should consider performing atmospheric monitoring (see Appendix I for more information about atmospheric monitoring) for airborne asbestos fibres to validate the controls implemented.

(a) Eliminate any risk

212. An employer must, so far as is reasonably practicable, eliminate any risk associated with an asbestos-related activity.

OHS Regulations r307(1)

(b) Reduce any risk by isolation or using engineering controls

213. If it is not reasonably practicable to eliminate a risk associated with an asbestos-related activity, the employer must reduce the risk, so far as is reasonably practicable, by isolation, using engineering controls, or a combination of these risk control measures.

OHS Regulations r307(2)

▪ Types of **isolation** includes:

– **Isolation by barrier** – this method involves reducing the risk to health by placing a barrier between people and the hazard. The purpose of the barrier is to prevent the asbestos fibres from becoming airborne and to prevent persons from being exposed to the airborne asbestos fibres.

An example of isolation by barrier is applying a small amount of silicon or paste to the surface of an AC sheet where a hole will be drilled. When the drill bit is drilled through the paste into the sheet and is removed, any loose fibres are collected in the paste, preventing them from becoming airborne. After drilling, the paste can be wiped clean with a rag and must be disposed of as asbestos waste OHS Regulations r5.

Asbestos-related activities

- **Isolation by distance** – this method involves reducing the risk to health by ensuring there is an appropriate distance between the hazard and people in the workplace by designating an area where an asbestos-related activity will be conducted. Entry to this area needs to be restricted to authorised persons only.

An example of isolation by distance is used in the laboratory analysis of suspected asbestos samples. The laboratory is isolated by distance from other work areas. Signs and barriers are used to communicate that access to the area is restricted during the activity. The activity also requires safe work procedures but the isolation control ensures that other employees are not at risk due to their distance from the activity. All employees are provided with the necessary instruction and training so they understand the reason for the risk control measure and the relevant safety procedures.

- **Engineering controls** can reduce the risk to health by suppressing or containing airborne asbestos fibres at the source or by minimising the amount of the airborne asbestos fibres released into the work environment.

An example of an engineering control is the use of a mini-enclosure to isolate the source of asbestos fibres combined with the use of extraction to capture and remove airborne asbestos fibres from the air in the work environment.

This approach could be used for the task of removing and replacing the lock mechanisms from an asbestos-containing fire door. See Figures 4 to 6 on page 61.

A purpose-built adjustable perspex box is fitted to the door surrounding the lock and handles on both sides of the door. Adjustments can be made to ensure a secure fit to the door and appropriate adhesive tape used to seal any possible gaps between the enclosure and the door. The box has access points for the operator's arms to enable work to be done on the lock, as well as an entry point for a vacuum hose. A Dust Class H vacuum cleaner can create negative pressure inside the enclosure to prevent fibres from escaping and can also be held directly at the source to capture any fibres that become airborne as the lock is removed from the door. On completion of the task, the Dust Class H vacuum cleaner is used to clean and decontaminate the enclosure as well as the operator's arms (before removing them).

(c) Reduce any risk that remains by using administrative controls

214. If the employer has attempted to reduce the risk to health through elimination, isolation, and engineering controls so far as is reasonably practicable, and a risk associated with an asbestos-related activity remains, the employer must reduce the risk so far as is reasonably practicable by using **administrative controls**.
OHS Regulations r307(3)

Asbestos-related activities

215. Administrative controls are systems of work or work procedures designed to control the risk and therefore administrative controls are lower order controls that are not as effective as the higher order risk control measures such as elimination, isolation and engineering. This is because administrative controls are systems or procedures that rely on human behaviour to be effective and can easily fail. The employer must ensure that administrative controls are properly installed, used and maintained. **OHS Regulations r18(1)**
216. Employers must provide appropriate training on the safe use of administrative controls (see 'Information, instruction, training, and supervision' on page 58).

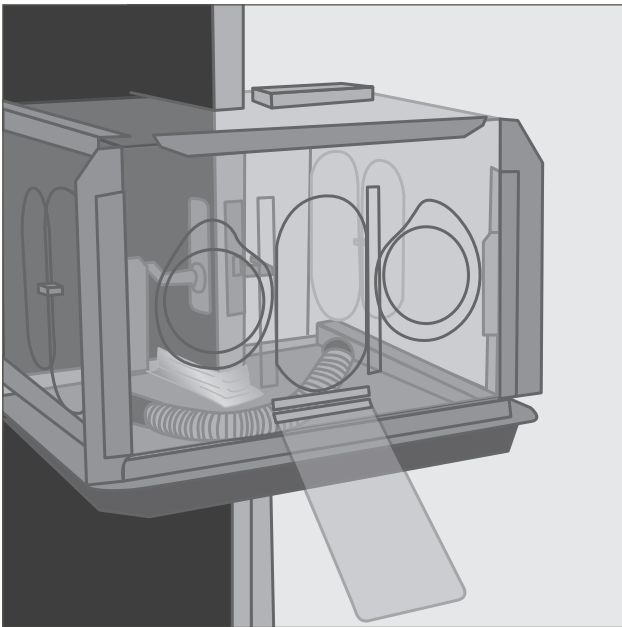

Figure 4: Front view showing entry holes for arms and tools as well as the vacuum hose inside the enclosure.

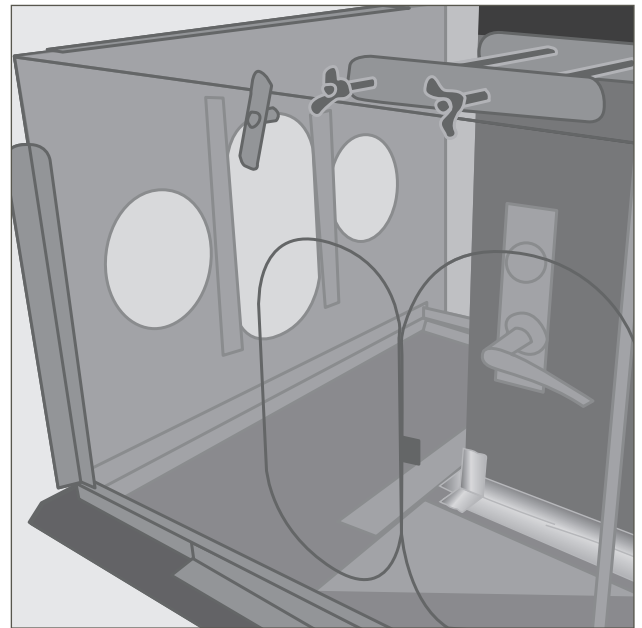

Figure 5: Side view showing the enclosure fitted around the door.



Figure 6: Side view showing the operator using the vacuum hose to 'shadow vac' below the screw as it is unscrewed from the lock housing.

Asbestos-related activities

217. For some asbestos-related activities, where there are no higher order risk control measures, administrative controls may be the only reasonably practicable way to control risk. An example of an administrative control for an asbestos-related activity is a procedure for collecting samples of ACM for analysis. Collecting the samples may involve breaking or dislodging ACM which can lead to the release of airborne asbestos fibres and consequently, a risk to health.
218. A safe work procedure for this activity should include actions such as:
- isolating the area where the sample is to be collected
 - assessing if the area is safe to enter
 - minimising dust
 - wearing suitable PPE
 - sealing the samples
 - storing and transporting samples in a safe and secure manner.
219. For the administrative control measure to be effective and reduce risk, the person conducting the sampling needs to understand the risk and implement the safe work procedure. If the procedure is not followed, the health of the person conducting the sampling and others in the workplace may be at risk (see Appendix C for further information on taking samples of suspected asbestos).
- (d) Reduce any risk that remains by using personal protective equipment**
220. If the employer has attempted to reduce the risk to health through isolation, engineering, and administrative controls so far as is reasonably practicable, and a risk associated with an asbestos-related activity remains, the employer must reduce the risk so far as is reasonably practicable by providing PPE to employees (including independent contractors) at risk. [OHS Regulations r307\(4\)](#)
221. If an employer provides PPE, they must ensure that the person carrying out the asbestos-related activity is provided with personal protective clothing and RPE that is suitable for the activity being carried out and correctly fitted. [OHS Regulations r307\(5\)](#)
222. Although PPE can be effective in controlling the risk from airborne asbestos fibres, the successful implementation and maintenance of this risk control measure requires further action and resources, which includes but is not limited to:
- the correct selection of appropriate PPE, including respirator, cartridge and coveralls
 - the issuing of PPE to each individual
 - the provision of appropriate training and supervision to all employees who are required to conduct asbestos-related activity and wear PPE to enable them to fit and use the equipment correctly and conduct the activity in a safe manner
 - ensuring PPE is properly used and maintained – non-disposable respirators need to be checked before and after use to ensure the components are in good working order and are not damaged
 - employee compliance and support for the system – while at work, employees have a duty to take reasonable care for their own health and safety. [OHS Act s25](#) This includes using PPE when it is required to control a risk associated with an asbestos-related activity. An understanding of the risk to health of asbestos, the higher order risk control measures already in place and use PPE to further reduce the risk to health all contribute to employees' willingness to use PPE.
223. For more information see 'Appendix H – Selection and use of personal protective equipment and clothing for asbestos-related activities' on page 87.

Employer's duty to review and revise risk control measures

224. An employer must review and, if necessary, revise any measures implemented to control risks associated with an asbestos-related activity:

- before any change is made to systems of work related to the activity that is likely to increase the risk to health or safety
- after any incident occurs to which Part 5 of the OHS Act applies that involves an asbestos-related activity
- if, for any other reason, the risk controls do not adequately control the risks, or
- after receiving a request from an HSR. [OHS Regulations r308\(1\)](#)

225. An HSR may request a review if they believe on reasonable grounds that any of the above circumstances exist or the employer has failed to properly review the risk control measures or take account of any of the above circumstances in conducting a review of, or revising, the risk control measures. [OHS Regulations r308\(2\)](#)

Signs and barricades to be used and work area to be separated

226. An employer must ensure that the work area used for an asbestos-related activity is kept separate from any other work area. [OHS Regulations r309\(a\)](#) The following needs to be considered when determining how best to do this:

- What is the asbestos-related activity and what form of asbestos is involved?
- Where is the activity conducted?
- How often and how long is the activity conducted?
- Is there potential for asbestos fibres to become airborne?

- What risk control measures are in place?
- Is there a physical barrier (such as a wall) in place to prevent the spread of dust in the air?
- What other activities are conducted in the workplace?

227. Taking these factors into account, separation may be achieved by conducting the asbestos-related activity in a separate room, or at a distance between three to 10 metres from other work areas.

228. An employer must also ensure that the work area used for an asbestos-related activity, so far as is reasonably possible, has appropriately placed signs and barricades that indicate the area where the activity is being carried out. [OHS Regulations r309\(b\)](#)

229. Signs need to be legible and placed securely in prominent locations (such as entry points to the work area) to ensure that all nearby people are informed that an asbestos-related activity is being carried out in that area.

230. Signs should be in accordance with *AS 1319 Safety signs for the occupational environment* (see Appendix F for examples).

231. Barricades can take various forms, from tape to solid hoarding. The type of barricading needs to reflect the level of risk. The placement of barricades will depend on the physical environment and needs to reflect the level of risk.

232. In combination with signage, barricades should serve the purpose of indicating the area is restricted due to an asbestos-related activity being conducted (see Figures 7 and 8).

Asbestos-related activities



Figure 7: An example of a barricade.

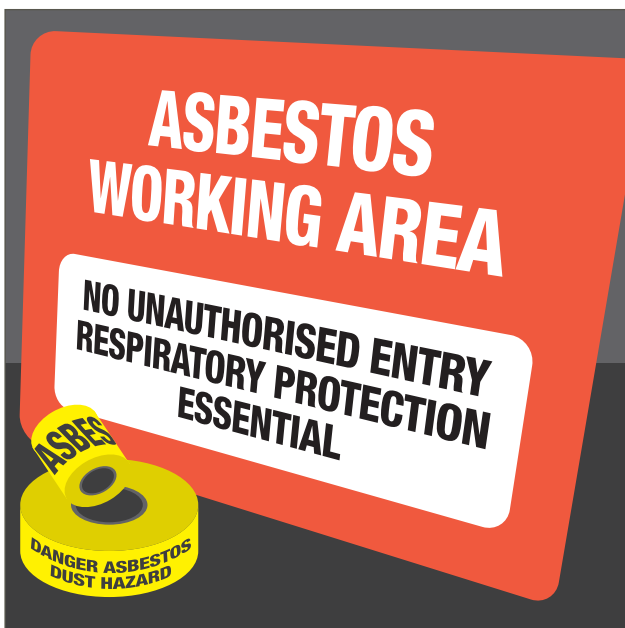

Figure 8: An example of appropriate signage.

Cleaning the work area

233. An employer must ensure, so far as is reasonably practicable, that the work area used for an asbestos-related activity is kept clean. [OHS Regulations r310\(1\)](#) For example, ensuring that there is no build-up of ACD or asbestos contaminated debris from the activity. A system needs to be in place for cleaning the work area each time it is used.
234. An employer must ensure that the methods used to clean the work area do not create a risk to health and do not have the potential to spread airborne asbestos fibres beyond the work area. [OHS Regulations r310\(2\)](#) A broom, brush, high-pressure water jet, power tool or similar tool or instruments must not be used or caused to be used on asbestos unless the use is controlled (for more information see 'Use of certain tools or instruments on asbestos' on page 16). [OHS Regulations r216\(1\)](#) This prohibition does not apply if airborne asbestos fibre levels do not exceed of 0.01 f/ml while the tool or instrument is in use. [OHS Regulations r216\(2\)](#)
235. A Dust Class H vacuum cleaner is suitable for cleaning if the area is dry but would likely be ineffective if the area is wet because the filter may become damaged.
236. Damp rags can be used to clean dusty surfaces that are hard to reach with a Dust Class H vacuum cleaner. Rags used for asbestos-related activities are asbestos waste and must be contained and disposed of as soon as reasonably practicable in an appropriate manner that eliminates the release of airborne asbestos fibres (see 'Employer's duty to contain and dispose of asbestos waste' on page 70).

Using and emptying Dust Class H vacuum cleaners

237. Vacuum cleaners used to collect asbestos need to be designed and constructed in accordance with the Dust Class H (high hazard) requirements of AS/NZS 60335.2.69 *Household and similar electrical appliances – safety – particular requirements for wet and dry vacuum cleaners, including power brush, for commercial use* or its equivalent.
238. Filters for Dust Class H vacuum cleaners (commonly referred to as Class H filters) need to conform to the requirements of AS 4260 *High efficiency particulate air (HEPA) filters – classification, construction and performance* or its equivalent. Employers need to ensure Class H filters have a performance of Grade 3 or higher to achieve the efficiency referred to in Annex AA of AS/NZS 60335.2.69 (fibre penetration of less than 0.005%).

Equivalent standards may have other filter classification systems, for example, the European Standard EN 1822 *High efficiency particulate air filters* would require the filter to be classed as H14.

239. Employers should request written confirmation from suppliers that Dust Class H vacuum cleaners that are in use, or are intended to be used, conform with the above standards.
240. Dust Class H vacuum cleaners should only be used for collecting small pieces of asbestos, dust and debris. Larger pieces should be picked up and placed in a suitable asbestos waste container. Larger pieces of asbestos should never be broken into smaller sizes for vacuuming.
241. Dust Class H vacuum cleaners should not be used for vacuuming wet materials because this can damage the HEPA filter.
242. Ensure the correct attachment to the Dust Class H vacuum cleaner for the type of surface being cleaned is used. Note that brush attachments are difficult to clean properly and therefore are not recommended.



Figure 9: A Dust Class H vacuum cleaner.

Warning: Domestic vacuum cleaners should never be used as they are not designed and constructed in accordance with the Dust Class H (high hazard) requirements of AS/NZS 60335.2.69 *Household and similar electrical appliances – safety – particular requirements for wet and dry vacuum cleaners, including power brush, for commercial use*.

Asbestos-related activities

243. Emptying Dust Class H asbestos vacuum cleaners may be the most dangerous part of working with ACM. Unless the job is done in a safe manner, the person could be exposed to concentrated ACD as well as contaminating the area and potentially exposing others to airborne asbestos fibres.
244. Employers must provide information, instruction and training to employees as is necessary to enable them to perform their work in a way that is safe and without risks to health. OHS Act s21(1) and (2)(e) This includes ensuring any employee undertaking the task of emptying Dust Class H asbestos vacuum cleaners has the appropriate level of training and is provided information and instruction on how to safely perform the task.
245. Employers need to consider whether it is necessary for an asbestos removal licence holder to be contracted to empty and decontaminate the Dust Class H vacuum cleaner as well as dispose of the asbestos waste.
246. In order to provide and maintain a safe working environment, employers need to establish general maintenance procedures in relation to Dust Class H vacuum cleaners (including emptying) that are in accordance with manufacturer instructions to prevent exposure to airborne asbestos fibres. This needs to be done in a controlled environment by a person with the requisite knowledge, skills and experience whilst wearing appropriate PPE. It may be safer to empty the vacuum cleaner in the asbestos work area to avoid cross contamination.
247. An employer must ensure that any equipment that is used for an asbestos-related activity that is likely to be contaminated with asbestos (for example, a Dust Class H vacuum cleaner and its attachments) is decontaminated or placed in a sealed container, the exterior of which is decontaminated (for example, by wet wiping), before removal from the work area used for the asbestos-related activity (see 'Decontamination at the end of the activity' on page 69). OHS Regulations r314(2)
248. The Dust Class H vacuum cleaner case, hose and attachments need to be visually inspected and cleaned with the vacuum cleaner, followed by damp rags. Place a cap over the opening to the vacuum cleaner when the attachments are removed.
249. When required, remove the waste bag and filter in accordance with the manufacturer's instructions and dispose of them as asbestos waste. Wipe the inside and outside of the vacuum cleaner with damp rags (dispose of rags as asbestos waste after use).
250. In between asbestos-related activities, the vacuum cleaner needs to be isolated and identified as being exposed to asbestos to prevent untrained persons using it for other general purposes.
251. Whenever possible, a Dust Class H vacuum cleaner should not be hired as it can be difficult to fully decontaminate. If hiring is necessary, a Dust Class H vacuum cleaner needs to be:
 - hired from organisations that supply Dust Class H vacuum cleaners specifically for work with asbestos, and
 - transported in a sealed airtight container with instructions that it may be removed from the container only when it is inside the asbestos work area and users are wearing appropriate PPE.

Asbestos-related activities

252. Organisations that supply Dust Class H vacuum cleaners need to ensure, so far as is reasonably practicable, that vacuum cleaners, filters and bags are maintained in good working order and continue to meet the relevant standards.

Warning: Unless proper precautions are taken, employees and other people may be exposed to airborne asbestos fibre levels exceeding the asbestos exposure standard.

Medical examinations for employees engaged in asbestos-related activities

253. The purpose of medical examinations is to monitor the health of persons engaged in ongoing asbestos-related activities to identify any changes in their health status due to occupational exposure to asbestos.
254. An employer must arrange for an appropriate medical examination to be conducted by a registered medical practitioner for each employee and independent contractor engaged in **ongoing asbestos-related activities** if there is a risk of exposure to airborne asbestos fibres in excess of one half of the exposure standard. [OHS Regulations r311\(1\) and \(5\)](#) RPE must not be taken into account in establishing whether there is a risk of exposure to airborne asbestos fibres in excess of one half of the asbestos exposure standard. [OHS Regulations r311\(2\)](#)

Ongoing asbestos-related activities are activities that are not a 'one off' and will continue as part of the employer's regular or routine work.

For example, a plumbing company has a long term contract with a client to undertake various maintenance activities which occasionally include accessing an asbestos-containing boiler for the purposes of enclosing/sealing various parts of the boiler. As there is a risk of exposure to airborne asbestos fibres in excess of one half of the exposure standard, this would be considered to be an ongoing asbestos-related activity.

255. An employer must ensure that atmospheric monitoring (personal air monitoring of employees) is provided if there is uncertainty (based on reasonable grounds) as to whether a medical examination may be required. [OHS Regulations r311\(3\)](#)
256. An employer must ensure that medical examinations are provided to an employee (including an independent contractor):
- at intervals of not more than two years, and
 - within 30 days after the employee ceased an asbestos-related activity (unless the employee has had a relevant medical examination within the preceding year). [OHS Regulations r311\(4\)](#)

Medical examinations are typically simple and may include a discussion about whether the employee has had a history of exposure to airborne asbestos fibres. A simple lung function test known as spirometry (where the person exhales into a tube) may be conducted to test lung performance. The registered medical practitioner may also recommend an x-ray.

257. The registered medical practitioner needs to be aware of WorkSafe's guidance on health monitoring (go to [worksafe.vic.gov.au](https://www.worksafe.vic.gov.au)).

Employers to obtain results of asbestos medical examinations

258. The employer arranging the medical examination must:
- pay for any medical examinations required under 'Part 4.4 – Asbestos' of the OHS Regulations. [OHS Regulations r19\(3\)](#)
 - obtain a summary of results of a medical examination of a person indicating whether an asbestos-related disease exists and the person's fitness for asbestos-related activities. [OHS Regulations r313\(1\)](#)
 - retain a copy of the summary of results for 30 years or a lesser period determined by WorkSafe. [OHS Regulations r313\(2\)](#)
- Note:** If WorkSafe makes a determination of the minimum record retention period it will publish a notice in the Government Gazette and, as soon as reasonably possible, in a newspaper circulating generally throughout Victoria. For further information go to worksafe.vic.gov.au.
259. The employer must provide a copy of the results of a medical examination report or summary:
- to the person to whom the report or summary relates as soon as reasonably possible after the employer receives the report or summary
 - if the person to whom the report or summary relates authorises in writing a third party to have access to the report or summary, to that third party, and
 - if WorkSafe requests a copy of the report or summary, or if the employer is otherwise required by the OHS Regulations to give WorkSafe a copy of the report or summary, to WorkSafe. [OHS Regulations r20\(2\)](#)

Section 69 of the OHS Act provides that the HSR of a DWG must be allowed access to information that an employer has relating to the health and safety of the members of the group. This section permits an HSR to have access to relevant medical information relating to an employee's health and safety that does not identify individual employees and, with the consent of an employee, medical information that identifies that employee.

Results of atmospheric monitoring to be made available

260. An employer must ensure that copies of the results of atmospheric monitoring are readily accessible to the HSR of any affected DWG and to the affected employees. [OHS Regulations r312](#)

Decontamination at the end of the activity

Decontaminating the work area

261. Employers must provide and maintain for employees systems of work that are, so far as is reasonably practicable, safe and without risks to health. [OHS Act s21\(2\)\(a\)](#) This includes systems of work for decontaminating the work area when carrying out asbestos-related activities.
262. A Dust Class H vacuum cleaner (see 'Using and emptying Dust Class H vacuum cleaners' on page 65) or damp rags should be used to decontaminate the work area. Rags used to decontaminate the work area are asbestos waste and must be contained and disposed of as soon as reasonably practicable in an appropriate manner that eliminates the release of airborne asbestos fibres (see 'Employer's duty to contain and dispose of asbestos waste' on page 70) [OHS Regulations r316\(a\) and \(b\)](#).

Asbestos-related activities

263. If work is to be carried out near electrical hazards, risks associated with electrocution and electric shock need to be controlled.
264. As part of decontamination, particular attention needs to be paid to walls, ledges, fittings and furnishings where ACD and debris may accumulate.

Warning: Never re-soak a rag contaminated with asbestos as this will contaminate the water. If contamination of the bucket of water is avoided, no special precautions are needed for disposal of the water.

Decontaminating equipment

265. An employer carrying out an asbestos-related activity must ensure that any equipment (other than PPE) that is used for the activity and that is likely to be contaminated with asbestos is:
- decontaminated before removal from the work area used for the activity, or
 - placed in a sealed container, the exterior of which is decontaminated before the container is removed from the area used for the activity. [OHS Regulations r314\(2\)](#)
266. A Dust Class H vacuum cleaner (see 'Using and emptying Dust Class H vacuum cleaners' on page 65) or damp rags should be used to decontaminate equipment. In some cases, solvent-based cleaning products may assist in decontamination. The decontamination method used depends on its practicality, the level of contamination and the presence of any electrical hazards.
267. An employer must obtain a current safety data sheet (SDS) on or before the first supply of a hazardous substance (including solvent-based cleaning products) to the employer's workplace. [OHS Regulations r155](#) An employer must, so far as is reasonably practicable, control any risk associated with hazardous substances at the employer's workplace by implementing risk control measures (including personal protective equipment and clothing) in accordance with the relevant hierarchy of control. [OHS Regulations r163](#)
268. Any equipment (other than PPE) that is used for an asbestos-related activity that is not decontaminated, must be placed in a sealed container, the exterior of which is decontaminated (for example, by wet wiping) before the container is removed from the work area used for the activity. [OHS Regulations r314\(2\)\(b\)](#) Equipment needs to:
- be tagged to indicate asbestos contamination
 - be double bagged in clearly labelled asbestos bags with an appropriate warning statement (the exterior of the sealed container must be decontaminated before being removed from the asbestos work area)
 - remain sealed until they have been decontaminated or the commencement of the next asbestos-related activity (where the equipment can be taken into the next asbestos-related activity area and re-used under controlled conditions).

Asbestos-related activities

269. PPE needs to be worn when opening any sealed container containing asbestos contaminated equipment to clean or re-use the equipment. In some circumstances it may be more practical to dispose of contaminated equipment depending on the level of contamination, difficulty of decontamination, and ease of replacement.

Personal decontamination

270. Personal decontamination needs to be undertaken each time a person leaves the asbestos work area. Personal decontamination needs to be performed within the asbestos work area where re-contamination cannot occur.

271. An employer carrying out an asbestos-related activity must ensure that a person does not remove PPE that is likely to be contaminated with asbestos from the work area used for the activity unless the equipment is decontaminated or contained before being removed. [OHS Regulations r314\(1\)](#) Where PPE is removed from the work area for disposal or laundering purposes, it must be contained so as to eliminate the release of airborne asbestos fibres [OHS Regulations r315, r317\(2\)\(a\)](#) (see pages 70 to 74 for more information). These practices help to control the release of airborne asbestos fibres and ensure that other areas in the workplace are not contaminated.

272. Employers need to ensure that employees remove all visible ACD from protective clothing and footwear before leaving the asbestos work area using a Dust Class H vacuum cleaner and/or wet wiping with a damp rag. Use damp rags with a gentle patting action (rubbing can disturb fibres) or spray overalls with a fine mist to suppress ACD. Where there are two employees they can help each other. Footwear needs to also be wet-wiped.

273. While still wearing their respirator, employees need to carefully peel off the coveralls inside out and then place them into a sealed asbestos-waste container for disposal or laundering.

274. RPE needs to be worn until all contaminated coveralls and clothing has been vacuumed and/or removed and bagged for disposal or laundering and personal washing has been completed. All waste bags, including those used for PPE, need to be double bagged. After removing RPE, employees need to wash their face and hands and clean under their fingernails.

Employer's duty to contain and dispose of asbestos waste

275. Asbestos waste includes any:

- asbestos derived from or associated with the asbestos-related activity
- disposable personal protective clothing or PPE contaminated with asbestos
- rags used to clean the area contaminated with asbestos
- tools or equipment that cannot be decontaminated or are no longer required. [OHS Regulations r5](#)

Asbestos-related activities

276. A waste containment and disposal program is a useful way of controlling the risk associated with asbestos waste. The program needs to take into account:

- the containment of asbestos waste so as to eliminate the release of airborne asbestos fibres
- labelling to indicate the presence of the asbestos waste
- the location and security of asbestos waste storage on site for disposal
- the transport of asbestos waste within the site and off site
- the location of a waste disposal site licensed or exempted by the EPA
- any approvals and site requirements that may apply to the waste disposal site licensed or exempted by the EPA (for example, the amount and dimensions of asbestos waste that can be disposed of).

A waste disposal site licensed or exempted by the EPA means premises:

- in respect of which the occupier is licensed by the EPA to dispose of asbestos waste
- to which regulation 12 of the Environment Protection (Scheduled Premises and Exemptions) Regulations 2007 applies in relation to the disposal, or
- set out in a classification under the Environment Protection (Industrial Waste Resource) Regulations 2009 that classifies asbestos waste as non-prescribed industrial waste.

277. An employer carrying out an asbestos-related activity must ensure that any asbestos waste is contained so as to eliminate the release of airborne asbestos fibres and the exterior of the container is decontaminated before being removed from the work area used for the activity and indicates the presence of asbestos.

OHS Regulations r315

278. Containment may be achieved by the use of double asbestos waste bags or a polythene-lined drum or bin. Loose asbestos waste should not be allowed to accumulate within the asbestos work area.

Asbestos-related activities

Bags for containing asbestos waste

279. Asbestos waste needs to be contained in asbestos waste bags (minimum 200 micron thickness). To assist in manual handling, asbestos waste bags should not be more than 1200mm long and 900mm wide. The exterior of each asbestos waste container (including asbestos waste bags) must indicate the presence of asbestos, for example labelled with an appropriate warning (see Figure 10). OHS Regulations r315(b)(ii)



Figure 10: An asbestos waste bag with appropriate warnings.

280. To minimise the risk of a bag tearing or splitting and to assist in manual handling, asbestos waste bags should not be filled more than half full and excess air gently evacuated from the asbestos waste bag in a way that does not cause the release of dust. Depending on the weight of the items placed in the bag, half filling a bag may be excessive.

281. Bags need to be twisted tightly and have the neck folded over and secured with appropriate adhesive tape (for example, cloth tape with a plastic coating that can be easily decontaminated) (referred to as *goose-necking*). The external surface of each sealed bag must be decontaminated before being removed from the work area. OHS Regulations r315(b)(ii) This needs to be done at the 'clean' end of a decontamination area or at the designated boundary of the asbestos-related activity area. Once decontaminated, it needs to be placed in a second clean asbestos waste bag, goose-necked and then taken away from the asbestos work area for disposal.

Waste drums, bins, or skips

282. All drums, bins, or skips used in relation to the disposal of asbestos waste should be lined with heavy-duty polythene sheeting (minimum 200 micron thickness) and labels indicating the presence of asbestos waste must be placed on the exterior of each drum, bin, or skip. OHS Regulations r315(b)(ii) An example of appropriate wording is: **'Danger: Asbestos. Do not break seal'**.
283. Any risks associated with the hazardous manual handling of drums or bins must be controlled. OHS Regulations r27 Drums or bins should not be moved manually once they have been filled. Trolleys or drum lifters should be used.

Disposal of asbestos waste

284. An employer carrying out an asbestos-related activity must ensure that asbestos waste is disposed of as soon as reasonably practicable, in an appropriate manner that eliminates the release of airborne asbestos fibres, and at a **waste disposal site licensed or exempted by the EPA**. OHS Regulations r316

Asbestos-related activities

285. Asbestos waste stored for the purposes of disposal at the workplace must be stored securely (for example, in locked areas or containers), identified to indicate the likely or actual presence of asbestos (for example, labelled), and contained so as to eliminate the release of asbestos fibres (for example, in solid containers such as drums or lidded bins, or lidded skips).

OHS Regulations r220(2)(a)

286. The transport and disposal of asbestos waste must be undertaken in accordance with the OHS Regulations and EPA requirements. The person engaged to transport asbestos waste for disposal purposes needs to ensure that:

- asbestos waste is contained so as to eliminate the release of airborne asbestos fibres
- they hold an EPA waste transport permit
- the vehicle is fit for purpose and meets the requirements outlined in the EPA vehicle guidelines
- the driver holds a driver training certificate in the handling or transport of asbestos waste
- asbestos waste containers are secure during transport
- the method of unloading the asbestos waste is safe.

For information on licensing of waste transport vehicles and waste disposal sites licensed or exempted by the EPA go to epa.vic.gov.au.

It is recommended that packaging, transporting and disposing of asbestos waste be undertaken by asbestos removal specialists. Firms specialising in asbestos removal can be found online or under *Asbestos removal* in the phone directory.

Laundering of clothing contaminated with asbestos

287. An employer carrying out an asbestos-related activity must provide for the laundering of personal protective clothing that is likely to be contaminated with asbestos at a laundry equipped to launder clothing contaminated with asbestos if that clothing is not contained and disposed of as asbestos waste (for more information see 'Employer's duty to contain and dispose of asbestos waste' on page 70).

OHS Regulations r317(1)

Note: Laundering of asbestos-contaminated protective clothing is not recommended due to physical damage/deterioration as a result of the work performed and cleaning process. If personal protective clothing is provided for laundering, the employer needs to demonstrate that the laundering process is effective.

288. Visible dust on personal protective clothing is a strong indication of asbestos contamination following an asbestos-related activity. However, absence of visible dust **does not** mean there is no asbestos contamination.

289. Disposable coveralls are recommended except in some limited circumstance where non-disposable protective clothing is appropriate for an asbestos-related activity (see 'Appendix H – Selection and use of personal protective equipment and clothing for asbestos-related activities' on page 87).

Asbestos-related activities

290. If an employer arranges for personal protective clothing that is likely to be contaminated with asbestos to be laundered, the employer must ensure that:
- the clothing is contained so as to eliminate the release of airborne asbestos fibres (for example, double bagged in two 200 micron-thick asbestos waste bags), and
 - the exterior of the container is decontaminated before being removed from the asbestos work area and indicates the presence of asbestos before the clothing is transferred to the laundry.
- OHS Regulations r317(2)**
- Note:** Contaminated protective clothing should never be laundered in homes.
291. Asbestos contaminated clothing needs to be removed damp and immediately wet down with a fine water mist.
292. The employer carrying out an asbestos-related activity needs to notify the laundry in advance of the presence of asbestos contaminated clothing.
293. An employer must ensure that, when laundering clothing contaminated with asbestos, the activity is carried out in a manner that, so far as is reasonably practicable, eliminates the release of airborne asbestos fibres.
- OHS Regulations r306** This may be achieved by placing the laundering room under negative pressure.
294. Employers laundering clothing contaminated with asbestos, need to ensure that the asbestos work area is constructed of smooth surfaces that are able to be lined with heavy-duty polythene sheeting (minimum 200 micron thickness).
295. Conventional washing machines can be used provided they are not used for other clothing. The clothing to be laundered should not be allowed to dry out before it is washed. Bags of asbestos-contaminated clothing need to be opened in the washing machine while being further saturated with water to minimise airborne asbestos fibres. The minimum recommended RPE for unloading clothes into the washing machine is a non-disposable half-face respirator with a P1 filter or P2 filter.
296. Employers must provide and maintain for employees systems of work that are, so far as is reasonably practicable, safe and without risks to health. **OHS Act s21(2)(a)** This includes systems of work for cleaning up spills and preventing flooding of neighbouring areas.
297. Asbestos contaminated containers/bags need to be disposed of as asbestos waste. Asbestos contaminated water needs to, so far as is reasonably practicable, be filtered and the filtering medium needs to, as soon as reasonably possible, be disposed of as asbestos waste.

Appendix A – The compliance framework

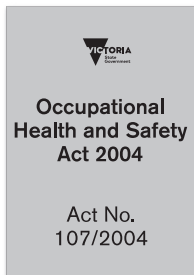

The Occupational Health and Safety Act 2004 (OHS Act) sets out the key principles, duties and rights in relation to occupational health and safety.

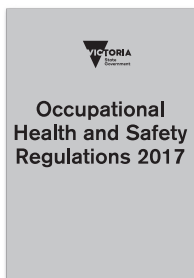

The Occupational Health and Safety Regulations 2017 (OHS Regulations) specify the way in which a duty imposed by the OHS Act must be performed, or prescribe procedural or administrative matters to support the OHS Act (eg requiring licences for specific activities, the keeping of records or giving notice).



Compliance codes provide practical guidance to duty holders. If a person complies with a provision of a compliance code, they are deemed to comply with the OHS legislative duty covered by the code provision. However, compliance codes are not mandatory, and a duty holder may choose to use some other way to achieve compliance.

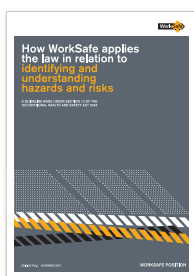

WorkSafe positions are guidelines made under section 12 of the OHS Act that state how WorkSafe will apply the OHS Act or OHS Regulations or exercise discretion under a provision of the OHS Act or OHS Regulations. WorkSafe positions are intended to provide certainty to duty holders and other affected parties.

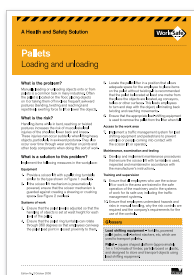

Non-statutory guidance includes information published by WorkSafe aimed at building people's knowledge and awareness of OHS issues, risks to health and safety, and the disciplines and techniques that can be applied to manage and control risks. Non-statutory guidance is not mandatory, nor does it provide any *deemed to comply* outcomes for duty holders. This guidance does, however, form part of the *state of knowledge* about OHS.

Appendix B – Definitions

(OHS Regulations r5)

Administrative control

A system of work or a work procedure that is designed to eliminate or reduce a risk, but does not include:

- (a) a physical control, or
- (b) the use of personal protective equipment.

Air-supplied respiratory protective equipment

A device that supplies air to the wearer from a source other than the ambient atmosphere.

Approved asbestos laboratory

A laboratory approved:

- (a) by NATA to perform asbestos fibre counting or to identify asbestos in samples, or
- (b) by a scheme determined by WorkSafe under regulation 6 of the OHS Regulations.

Note: If WorkSafe makes a determination of a scheme for the approval of laboratories it will publish a notice in the Government Gazette and, as soon as reasonably possible, in a newspaper circulating generally throughout Victoria. For further information go to worksafe.vic.gov.au.

Asbestos

- (a) the asbestiform varieties of mineral silicates belonging to the serpentine or amphibole groups of rock-forming minerals, including –
 - (i) actinolite asbestos
 - (ii) anthophyllite asbestos
 - (iii) chrysotile (white asbestos)
 - (iv) crocidolite (blue asbestos)
 - (v) grunerite asbestos (or amosite) (brown asbestos)
 - (vi) tremolite asbestos, or
- (b) any material or object, whether natural or manufactured, that contains one or more of the mineral silicates referred to in paragraph (a).

Asbestos-containing material (ACM)

Any manufactured material or object that, as part of its design, contains one or more of the mineral silicates referred to in paragraph (a) of the definition of **asbestos** (other than plant in which asbestos is fixed or installed).

Asbestos contaminated dust (ACD)

Dust that is, or is assumed under 'Part 4.4 – Asbestos of the OHS Regulations' to be, contaminated with asbestos.

Appendix B – Definitions

(OHS Regulations r5)

Asbestos exposure standard

0.1 f/ml of air measured in a person's breathing zone and expressed as a time weighted average fibre concentration of asbestos calculated over an eight-hour working day and measured over a minimum period of four hours in accordance with:

- (a) the Membrane Filter Method, or
- (b) a method determined by WorkSafe under regulation 6 of the OHS Regulations.

Note: If WorkSafe makes a determination of an exposure measurement method it will publish a notice in the Government Gazette and, as soon as reasonably possible, in a newspaper circulating generally throughout Victoria. For further information go to worksafe.vic.gov.au.

Asbestos paraoccupational air monitoring

A procedure by which air is sampled to estimate the airborne asbestos fibre concentration in the occupational environment, taken at fixed locations, usually between one and two metres above floor level, in accordance with:

- (a) the Membrane Filter Method, or
- (b) a method determined by WorkSafe under regulation 6 of the OHS Regulations.

Note: If WorkSafe makes a determination of an exposure measurement method it will publish a notice in the Government Gazette and, as soon as reasonably possible, in a newspaper circulating generally throughout Victoria. For further information go to worksafe.vic.gov.au.

Asbestos register

The asbestos register kept under regulation 227 as revised in accordance with 'Part 4.4 – Asbestos' of the OHS Regulations.

Asbestos-related activities

Has the meaning given by regulation 302 (for more information see 'Appendix G – Asbestos-related activities' on page 86).

Asbestos removal licence

- (a) a Class A asbestos removal licence, or
- (b) a Class B asbestos removal licence.

Asbestos removal licence holder

An employer or self-employed person who is the holder of an asbestos removal licence issued under 'Part 6.1 – Licences' of the OHS Regulations.

Asbestos removal work

The removal of asbestos that is present at a workplace, building, structure, ship or plant so that the asbestos is no longer present in that workplace, building, structure, ship or plant, up to the point of containment.

Asbestos waste

Asbestos removed and disposable items used during asbestos removal work or asbestos-related activities, including plastic sheeting and disposable personal protective clothing and disposable protective equipment including tools.

Atmospheric monitoring

A procedure by which air is sampled within the breathing zone of a person to measure and evaluate the person's exposure to airborne contaminants.

Breathing zone

A hemisphere of 300 millimetres radius extending in front of a person's face measured from the mid-point of an imaginary straight line joining the ears.

Domestic premises

Domestic premises used solely for domestic purposes.

Employer's asbestos register

The employer's asbestos register kept under regulation 235 as revised in accordance with 'Part 4.4 – Asbestos' of the OHS Regulations.

Appendix B – Definitions

(OHS Regulations r5)

Engineering control

A physical control of any kind that is designed to eliminate or reduce a risk, but does not include:

- (a) a system of work or procedure, or
- (b) the use of personal protective equipment.

Environment Protection Authority (EPA)

Has the same meaning as Authority has in the *Environment Protection Act 1970*.

Exposure standard

An exposure standard set out in the *Workplace Exposure Standards for Airborne Contaminants*, published by Safe Work Australia on its Internet site.

F/ml

Fibres per millilitre.

Friable

When dry:

- (a) may be crumbled, pulverised or reduced to powder by hand pressure, or
- (b) as a result of a work process becomes such that it may be crumbled, pulverised or reduced to powder by hand pressure.

HEPA filter

A high efficiency particulate air filter that is a disposable, extended media, dry type filter, in a rigid frame, with a minimum filtration efficiency of 99.97% filtration for nominal 0.3 micrometres (μm) diameter thermally generated dioctylphthalata particles or an equivalent efficiency for a specified alternative aerosol and with an initial maximum resistance to airflow of 250 pascals when tested at its rated airflow capacity.

Limited asbestos removal work

Asbestos removal work which is permitted under regulation 250 of the OHS Regulations.

Membrane Filter Method

The method for estimating airborne asbestos fibres in accordance with the *Guidance note on the membrane filter method for estimating airborne asbestos fibres* prepared by the National Health and Safety Commission and published in 2005.

NATA

The National Association of Testing Authorities (Australia).

Person who commissioned the asbestos removal work

The person managing or controlling a workplace or the employer who arranged for asbestos removal work to be performed.

Personal protective equipment (PPE)

Includes respiratory protective equipment and personal protective clothing.

Safe Work Australia (SWA)

Safe Work Australia established by section 5 of the *Safe Work Australia Act 2008* (Commonwealth).

Safe work method statement (SWMS)

Has the meaning given by regulation 324 of the OHS Regulations.

Safety data sheet

In relation to a hazardous substance, means a safety data sheet:

- (a) required to be prepared for the substance under regulation 144 of the OHS Regulations, or
- (b) prepared for the substance by the manufacturer or the importing supplier in accordance with equivalent legislation.

Appendix B – Definitions

(OHS Regulations r5)

Structure

In 'Part 4.4 – Asbestos' of the OHS Regulations, any construction, including a bridge, tunnel, shaft, dam, pipe or access pit, or any part of a construction, but does not include a building, ship or plant.

Type of asbestos-containing material

A description of asbestos-containing material.

Example: Asbestos-containing cement sheeting, cement pipes, vinyl tiles, sprayed insulation, telecommunications pits and pipes, pipe lagging, millboard and gaskets.

Appendix C – Taking asbestos samples

An employer must ensure that, when carrying out sampling involving suspected asbestos, the activity is carried out in a manner that, so far as is reasonably practicable, eliminates the release of airborne asbestos fibres. [OHS Regulations r306](#)

Before a sample of suspected asbestos is collected, the employer needs to:

- determine if there is a risk to the health of any person (including the person taking the sample) taking into account the nature and condition of the suspected asbestos and its location
- ensure that the person collecting the sample has the requisite knowledge, skills and experience in association with taking a sample of suspected asbestos (including the risks to health)
- assess the risk associated with collecting the suspected asbestos sample to ensure appropriate personal protective clothing and equipment is selected, provided and used during the task (for example, disposable coveralls and a non-disposable half-face respirator with a P1 filter or P2 filter). If the assessment has determined that a respirator is required ensure that it complies with *AS/NZS 1716 Respiratory protective devices*
- ensure that appropriate risk control measures are used to control the risk of generating airborne asbestos fibres during the sampling (including, where appropriate using a Dust Class H vacuum cleaner to capture asbestos-contaminated dust and using a water spray bottle with a fine mist to dampen surfaces)
- ensure that a safe method of breaking or dislodging the suspected asbestos sample without generating asbestos contaminated-dust is provided and followed
- ensure the sample is immediately placed in an appropriately secure and sealed container which is labelled with details such as the date, time, specific location of the suspect asbestos-containing material and the address of the site (the container must indicate the presence of asbestos)
- ensure any tools used to break or dislodge a suspected asbestos sample are decontaminated or placed into a sealed container which indicates the presence of asbestos before being removed from the work area
- ensure the area where the suspected asbestos sample is collected has been decontaminated, cleaned and made safe before the area is re-occupied by any person. This will usually be achieved using a Dust Class H vacuum cleaner and/or wet-wiping surfaces to clean up residual asbestos-contaminated dust
- ensure any asbestos waste (including asbestos contaminated dust collected by the Dust Class H vacuum cleaner, any debris caused by the sampling process, any material used to wipe up surfaces) is placed into a sealed and labelled asbestos container, for example, a 200 micron-thick asbestos waste bag and disposed of as asbestos waste

Appendix C – Taking asbestos samples

- ensure the person who has taken the suspected asbestos sample follows a suitable personal decontamination process appropriate to the level of risk, for example:
 - while still wearing RPE, remove and place coveralls (if used) into a sealed asbestos waste container for disposal (or laundering)
 - while still wearing RPE, wash face, hands and clean under fingernails with water
 - remove and place RPE into a labelled container.

The analysis technique used by an approved asbestos laboratory to identify asbestos in samples does not require the sample to be big. Typically, the sample is only required to be small (for example, the size of a 50 cent coin would generally be sufficient as long as it is a representative sample of the suspected ACM).

Appendix D – Example of an asbestos register

Asbestos register

Asbestos Register								
Workplace address: 1234 High Street					Conducted by: John Smith			
Type of asbestos (including type of ACM)	Specific location	Is this area inaccessible?	Source of unfixed or uninstalled asbestos	Friable or non-friable?	What is its condition?	Likely to sustain damage or deteriorate?	Activities that may disturb the asbestos	Date of identification
1. Vinyl tiles	Kitchen floor, ground floor, Building 3	No	n/a	Non-friable	Good, undisturbed	Not likely to sustain damage but over time the tiles will deteriorate and need replacing	None, under normal conditions of use	31/07/17
2. AC sheet	Wall at rear of the storage shed	No	n/a	Non-friable	Damaged, needs repair or removal	Yes, may be damaged further	Forklifts stacking pallets near the shed may hit the wall	31/07/17
3. AC sheet debris	NE corner of storage shed	No	Damaged AC sheet wall in shed due to impact	Non-friable	Damaged, needs removal	Yes	Any activities may disturb the debris – needs to be removed	31/07/17
4. Pipe lagging (insulation)	Along the western wall of plant room, Building 2	No	n/a	Friable	Deteriorating, old, needs removal	Yes, will deteriorate further	May be struck by ladders that are leant against the wall for storage	31/07/17
5. Sprayed asbestos insulation deemed to be present	Inside of cable shaft that runs from ground floor to the third floor, at the rear of Building 2	Yes, inaccessible	n/a	Friable	Assumed to be poor	Unlikely to sustain damage, likely to deteriorate over time	No	31/07/17

Appendix D – Example of an asbestos register

Asbestos register pro forma

Asbestos Register								
Workplace address:					Conducted by:			
Type of asbestos (including type of ACM)	Specific location	Is this area inaccessible?	Source of unfixed or uninstalled asbestos	Friable or non-friable?	What is its condition?	Likely to sustain damage or deteriorate?	Activities that may disturb the asbestos	Date of identification

Appendix E – Asbestos register duties

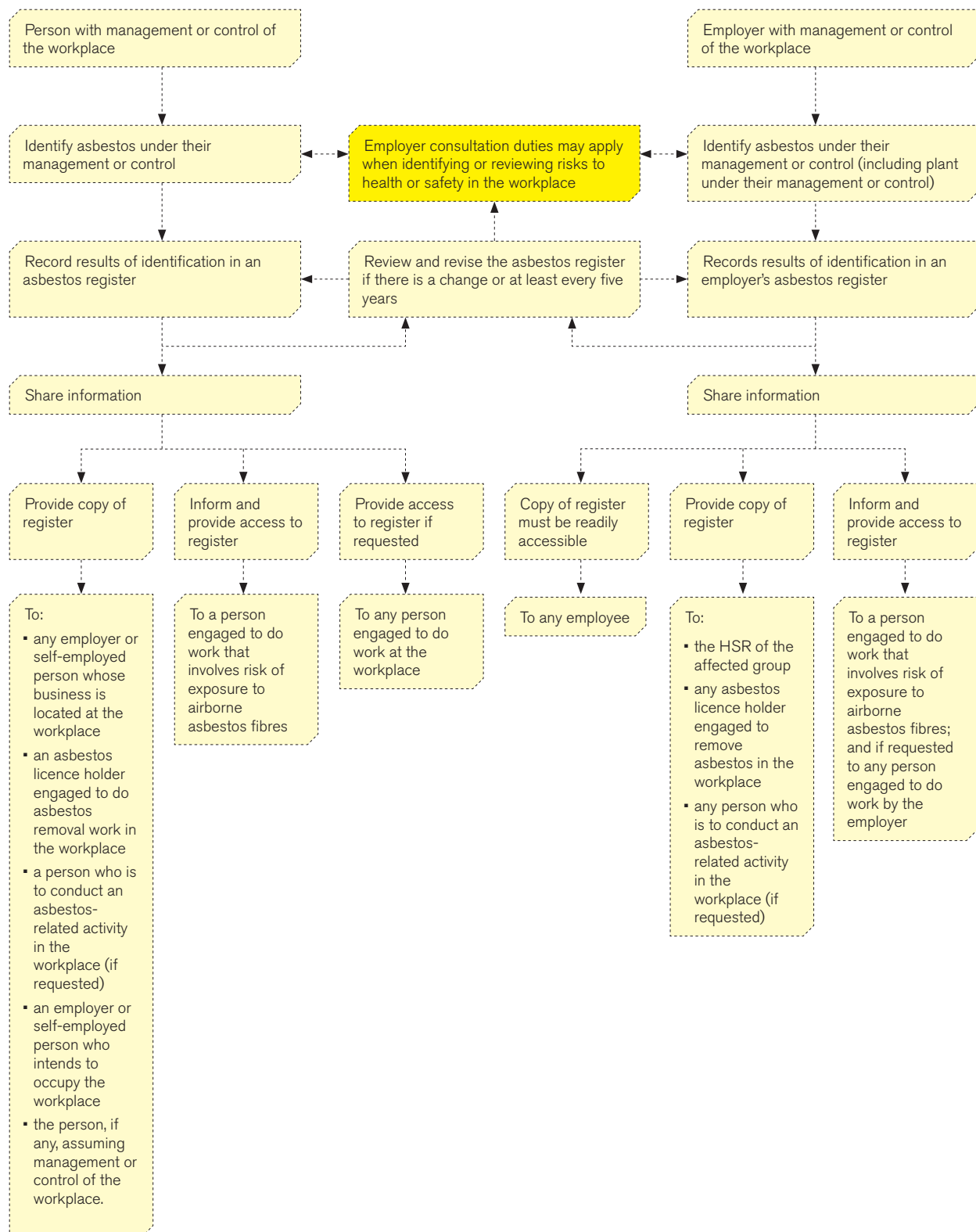

Appendix F – Signs and labels

Examples of signs and labels for indicating the presence of asbestos in the workplace:

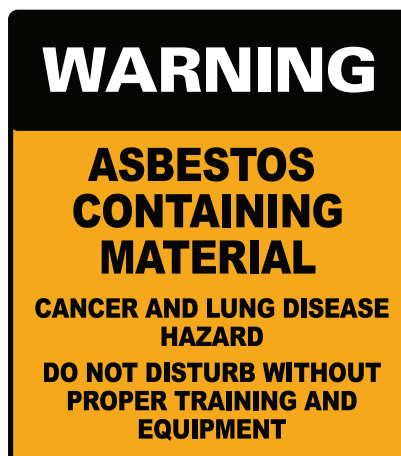

Appendix G – Asbestos-related activities

(OHS Regulations r302)

'Division 8 – Activities involving asbestos' of the OHS Regulations sets out the duties on employers where asbestos-related activities (other than asbestos removal work) are undertaken in their workplace. These activities include:

- (a) the handling, including for the purpose of removal or transport for disposal, of aircraft and automotive components that are asbestos-containing material or that have ACM fixed to them or installed in them
- (b) the laundering of clothing contaminated with asbestos
- (c) research involving asbestos
- (d) sampling or analysis involving suspected asbestos
- (e) the transport of asbestos waste for disposal purposes
- (f) working at premises:
 - (i) in respect of which the occupier is licensed by the Environment Protection Authority to dispose of asbestos waste
 - (ii) to which the Environment Protection (Scheduled Premises and Exemptions) Regulations 2007 applies in relation to the disposal, or
 - (iii) set out in a classification under the Environment Protection (Industrial Waste Resource) Regulations 2009 that classifies asbestos waste as non-prescribed industrial waste
- (g) the enclosing or sealing of asbestos
- (h) hand-drilling and cutting of ACM
- (i) maintenance of dust extraction equipment, contaminated with asbestos
- (j) processing of construction and demolition material in accordance with the method determined by WorkSafe
- (k) any other activity (other than asbestos removal work to which 'Division 7 – Removal of asbestos' applies) that is likely to produce airborne asbestos fibres in excess of one half of the asbestos exposure standard
- (l) any other activity determined by WorkSafe for the purposes of 'Division 8 – Activities involving asbestos'.

Appendix H – Selection and use of personal protective equipment and clothing for asbestos-related activities

If the employer has attempted to reduce the risk to health through elimination, isolation, engineering, and administrative controls so far as is reasonably practicable, and a risk associated with an asbestos-related activity remains, the employer must reduce the risk so far as is reasonably practicable by providing PPE to employees (including independent contractors) at risk. [OHS Regulations r307\(4\)](#) If the employer provides such PPE, the employer must ensure that the person carrying out the asbestos-related activity is provided with PPE that is suitable for the activity being carried out and correctly fitted. [OHS Regulations r307\(5\)](#)

The selection and use of PPE for an asbestos-related activity needs to be based on a risk assessment and determined by a person with the requisite knowledge, skills and experience of the activity and the potential risk to health.

When selecting PPE, the ease of decontaminating it needs to be considered. Where possible, disposable equipment should be used (including disposable respirators and coveralls that can be disposed of as asbestos waste). This reduces the risk of exposure to airborne asbestos fibres (if there are any) while cleaning and handling re-usable PPE.

When selecting personal protective clothing for an asbestos-related activity, factors such as potential heat stress need to be considered.

If an asbestos-related activity requires the use of other chemicals that are also hazardous substances, there will be further obligations under 'Part 4.1 – Hazardous substance' of the OHS Regulations. For more information see WorkSafe's *Hazardous substances compliance code* (2018).

Coveralls

In most cases, a risk assessment for an asbestos-related activity may require coveralls to be worn. The risk assessment needs to take into account the nature and duration of the work, the type and condition of the ACM and the likelihood that ACD will be generated during the task.

Personal protective clothing (including coveralls) must be suitable for the asbestos-related activity being carried out. [OHS Regulations r307\(5\)\(a\)\(i\)](#) For example:

- having fitted hoods and cuffs
- being made from material capable of providing adequate protection against asbestos fibre penetration
- not having external pockets or velcro fastenings (as these can become easily contaminated and are difficult to decontaminate).

Note: Clothing made from wool or other materials that trap fibrous dusts (for example, polar fleece) should not be worn by persons carrying out an asbestos-related activity.

Personal protective clothing (including coveralls and any clothing worn under coveralls) that is likely to be contaminated with asbestos must not be removed from the work area used for the activity unless the clothing is decontaminated or contained before removal (see 'Personal decontamination' on page 70). [OHS Regulations r314\(1\)](#)

Appendix H – Selection and use of personal protective equipment and clothing for asbestos-related activities

Where contaminated coveralls are contained and removed from the work area, they must be:

- disposed of as asbestos waste as soon as reasonably possible (see 'Employer's duty to contain and dispose of asbestos waste' on page 70) or stored for the purpose of disposal OHS Regulations r316, r220(2)(a)
- provided for laundering (see 'Laundering of clothing contaminated with asbestos' on page 73) or stored for the purpose of laundering. OHS Regulations r317, r220(2)(a)

Note: Laundering of asbestos-contaminated protective clothing is not recommended due to physical damage/deterioration as a result of the work performed and cleaning process. If personal protective clothing is provided for laundering, the employer needs to demonstrate that the laundering process is effective.

Disposable yet durable coveralls are recommended (disposable coveralls that can be easily torn are not suitable and should not be worn). Disposable coveralls used during asbestos-related activities:

- must be disposed of as asbestos waste (see 'Employer's duty to contain and dispose of asbestos waste' on page 70) and need to be disposed of after a single use
- need to be of a suitable standard to prevent, so far as is reasonably practicable, penetration of asbestos fibres. Disposable type 5 category 3 coveralls (that meet EN ISO 13982 *Protective clothing for use against solid particulates*) or an equivalent would meet this standard.
- should be one size too big as this will help prevent ripping at the seams:
 - if cuffs are loose ensure they are sealed with appropriate adhesive tape
 - ensure coverall legs are worn over footwear as tucking them in lets dust in
 - ensure the hood is worn over the respirator straps.

Disposable type 5 category 3 coveralls (that meet EN ISO 13982 *Protective clothing for use against solid particulates*) are tested to allow up to (or not permit more than) 15% inward leakage of fine particles in eight out of 10 suits tested. Coveralls that allow less inward leakage are available and may be used, however any risk of heat stress needs to be addressed/evaluated prior to using such coveralls – this may involve short use duration trials under supervision.

In some limited circumstances, for example if there is a fire hazard, disposable protective clothing is not appropriate and re-usable types need to be used.

Special consideration needs to be given to the risks of heat stress and burns from working in coveralls in hot conditions. When evaluating heat stress risks, humidity and air movement should be considered in addition to temperature. A person with the requisite knowledge, skills and experience needs to assess the risk and determine the most suitable protective clothing, decontamination procedures and system of work (including work rest regimes) in these situations.

Gloves

The use of gloves needs to be determined by a risk assessment. Personal protective clothing (including gloves) must be suitable for the activity being carried out OHS Regulations r307(5)(a)(i). If the activity is likely to involve the release of airborne asbestos fibres, disposable gloves are recommended. If latex gloves are used, low protein (powder free) gloves should be selected.

Note: Gloves may be unsuitable if dexterity is required in relation to the asbestos-related activity.

Personal protective clothing (including gloves) that are likely to be contaminated with asbestos must not be removed from the work area used for the activity unless the clothing is decontaminated or contained before removal (see 'Personal decontamination' on page 70). OHS Regulations r314(1)

Appendix H – Selection and use of personal protective equipment and clothing for asbestos-related activities

Where contaminated gloves are contained and removed from the work area, they must be:

- disposed of as asbestos waste as soon as reasonably possible (see 'Employer's duty to contain and dispose of asbestos waste' on page 70) or stored for the purpose of disposal OHS Regulations r316, r220(2)(a), or
- provided for laundering (see 'Laundering of clothing contaminated with asbestos' on page 73) or stored for the purpose of laundering. OHS Regulations r317, r220(2)(a)

Note: Laundering/cleaning gloves is not recommended due to physical damage/deterioration as a result of the work performed and cleaning process. If personal protective clothing is provided for laundering, the employer needs to demonstrate that the laundering process is effective.

While at work, an employee must take reasonable care of his or her own health and safety, this includes cleaning their hands and fingernails thoroughly after carrying out an asbestos-related activity regardless of whether gloves are used. OHS Act s25

Footwear

Personal protective clothing (including footwear such as steel-capped, rubber-soled work shoes or gumboots) must be suitable for the asbestos-related activity being carried out OHS Regulations r307(5)(a)(i). Footwear needs to be laceless as laces and eyelets are easily contaminated and difficult to clean. Safety footwear should not be shared due to hygiene reasons.

Personal protective clothing (including footwear) that is likely to be contaminated with asbestos must not be removed from the work area used for the activity unless the clothing is decontaminated or contained before removal (see 'Personal decontamination' on page 70). OHS Regulations r314(1)

Where contaminated footwear is contained and removed from the work area, it must be disposed of as asbestos waste as soon as reasonably possible (see 'Employer's duty to contain and dispose of asbestos waste' on page 70) or stored for the purpose of disposal OHS Regulations r316, r220(2)(a)

Headwear

In some instances headwear such as a cap for protection from the sun or a hard hat for protection from overhead hazards may be required.

Personal protective clothing (including headwear) that is likely to be contaminated with asbestos must not be removed from the work area used for the activity unless the clothing is decontaminated (see 'Personal decontamination' on page 70) or contained before removal. OHS Regulations r314(1)

Where contaminated headwear is contained and removed from the asbestos work area, it must be:

- disposed of as asbestos waste as soon as reasonably possible (see 'Employer's duty to contain and dispose of asbestos waste' on page 70) or stored for the purpose of disposal OHS Regulations r316, r220(2)(a), or
- provided for laundering (see 'Laundering of clothing contaminated with asbestos' on page 73) or stored for the purpose of laundering. OHS Regulations r317, r220(2)(a)

Note: Laundering/cleaning headwear is not recommended due to physical damage/deterioration as a result of the work performed and cleaning process. If personal protective clothing is provided for laundering, the employer needs to demonstrate that the laundering process is effective.

Appendix H – Selection and use of personal protective equipment and clothing for asbestos-related activities

Contaminated personal protective clothing that is stored for the purposes of disposal or laundering at the asbestos removal site must be:

- stored securely (for example, in locked areas or containers)
- identified to indicate the likely or actual presence of asbestos (for example, labelled)
- contained so as to eliminate the release of asbestos fibres (for example, in solid containers such as drums, lidded bins, or lidded skips), and
- disposed of or laundered as soon as reasonably possible.
OHS Regulations r220(2)(a)

For more information on the storage of asbestos waste see 'Employer's duty to contain and dispose of asbestos waste' on page 70.

Respiratory protective equipment

There is a wide range of RPE available to control exposure to airborne asbestos fibres.

The selection of suitable RPE depends on the nature of the asbestos-related activity, the probable maximum concentrations of airborne asbestos fibres likely to be encountered and any personal characteristics of the wearer (including medical conditions that may preclude the use of certain types of RPE). If there is uncertainty as to the suitability of a person to wear certain types of RPE (for example, negative pressure respiratory protective equipment), the employer needs to seek an assessment by a registered medical practitioner.

The diagrams on page 93 provide, in approximate order of increasing efficiency, an overview of some of the respirators that can be used for protection against airborne asbestos fibres. The protection afforded by each device depends not only on the design and fit of the respirator but upon the efficiency of the filters (ie P1, P2 or P3 – where P stands for particulate or dust).

AS/NZS 1715 *Selection, use and maintenance of respiratory protective equipment* and AS/NZS 1716 *Respiratory protective devices* provide detailed guidance on the selection, use and maintenance of RPE and need to be consulted for more detailed advice.

The table 'Selection of appropriate respiratory protective equipment' (page 94) provides guidance for the selection of appropriate RPE for different tasks, assuming the correct work procedures are being followed.

This guide does not take account of personal features, such as facial hair or the need to wear glasses (full protection will not be achieved if either of these factors interferes with the facial seal). It also does not take any account of potential misuse of the RPE.

A person with the requisite knowledge, skills and experience needs to determine the most appropriate respirator for the asbestos-related activity following a risk assessment. This person needs to have knowledge of the risks to health from exposure to airborne asbestos fibres, the nature of the activity to be performed and the risk control measures in place to control the risk. The person also needs to be familiar with the appropriate Australian Standards for RPE.

The respirators and filters presented in the table 'Selection of appropriate respiratory equipment' (see page 94) are the minimum recommended for the corresponding task. The most efficient respirator needs to be used.

It is recommended that non-disposable RPE be used where a half-face respirator has been determined as providing the required level of respiratory protection, as it is easier to establish if non-disposable RPE correctly fits a person's face.

Appendix H – Selection and use of personal protective equipment and clothing for asbestos-related activities

Types of respiratory protective equipment (see diagrams on page 93)

- Disposable, half-face particulate respirator (A).
- Half-face, particulate filter (cartridge) respirator (B).
- Powered, air-purifying, ventilated helmet respirator (C).
- Full-face, particulate, filter (cartridge) respirator (D).
- Full-face, powered air-purifying particulate respirator (E).
- Full-face, positive pressure demand air-line respirator (F).

Where a disposable mask has been selected for an asbestos-related activity, it needs to be Australian Standard-compliant and marked with the standard reference number as well as having two straps (not one).

Use and maintenance of respirators

If RPE is used to control a risk associated with an asbestos-related activity, the employer must provide RPE to employees at risk. **OHS Regulations r307(4)** RPE needs to be provided to individuals for their exclusive use. Not only is this important from a personal hygiene perspective, it also contributes to improved cooperation by employees to comply with the requirement to wear RPE and can also lead to employees taking better care of it as well.

The suitability of employees to undertake asbestos-related activities needs to be assessed by a qualified medical practitioner. Employees must be medically fit to wear RPE and medical advice should be sought if there is any uncertainty. If a medical condition precludes an employee from using a negative-pressure respirator, the employer needs to provide a continuous flow positive-pressure respirator (wherever possible).

Employers need to ensure that employees performing asbestos-related activities using negative-pressure respirators that require a facial seal are clean shaven – otherwise a correct fit and the required level of respiratory protection won't be achieved. Persons with beards, stubble or facial hair that come into contact with the respirator's facial seal need to use a continuous flow positive pressure respirator.

Employers must ensure that the person carrying out the asbestos-related activity is provided with RPE that is correctly fitted **OHS Regulations r307(5)**. A fit test, in accordance with *AS/NZS 1715 Selection, use and maintenance of respiratory protective equipment* and the manufacturer's instructions, needs to be performed to determine if RPE worn for asbestos-related activities correctly fits the person's face.

RPE needs to be worn in accordance with the manufacturer's instructions with the coverall hood worn over the respirator straps. The awkward position of the respirator straps may affect the airtight seal on the person's face.

A fit check (different to a fit test) in accordance with *AS/NZS 1715 Selection, use and maintenance of respiratory protective equipment* and the manufacturer's instructions needs to be performed immediately prior to commencing asbestos-related activities each time RPE is worn. This may help determine whether the respirator can provide an effective seal and protection if there are airborne asbestos fibres in the asbestos-related activity work area.

Respirators need to be worn until all contaminated clothing has been cleaned using a Dust Class H vacuum cleaner and/or wet-wiped, removed and securely contained for removal or disposal, and personal decontamination has been completed.

Appendix H – Selection and use of personal protective equipment and clothing for asbestos-related activities

RPE likely to be contaminated with asbestos must be decontaminated and contained before removal from the work area. The respirator should never be left lying around where it can collect dust and should never be dangled around an employee's neck when not in use. Non-disposable respirators need to be cleaned and decontaminated according to the manufacturer's instructions and stored in a clean, airtight container and out of sunlight when not in use.

Employers must provide and maintain for employees systems of work that are, so far as is reasonably practicable, safe and without risks to health. OHS Act s21(2)(a) This includes systems of work for cleaning, inspecting and maintaining non-disposable respirators. Records of all respirators issued should be established and maintained (for example, in a log book).

Respirators need to be maintained in a clean and good working condition. All parts need to be inspected before and after each use, including the valves and seals. A defective respirator needs to immediately stop being used and repaired or replaced.

The length of use of a particulate filter for asbestos-related activities depends on resistance to breathing (due to becoming clogged with trapped particles or damp conditions) and damage to the filter. The filters need to be replaced when damaged or when resistance increases and in accordance with the manufacturer's instructions. It also needs to be replaced before any manufacturer-recommended period has expired. Used filters that are being replaced must be disposed of as asbestos waste. Used filters should not be attempted to be cleaned and re-used.

Appendix H – Selection and use of personal protective equipment and clothing for asbestos-related activities

RPE must be suitable for the activity being carried out and correctly fitted. Coverall hoods need to be worn over the respirator straps. These diagrams are indicative only. In order to show the correct respirator fit, the following diagrams do not show the use of coverall hoods.

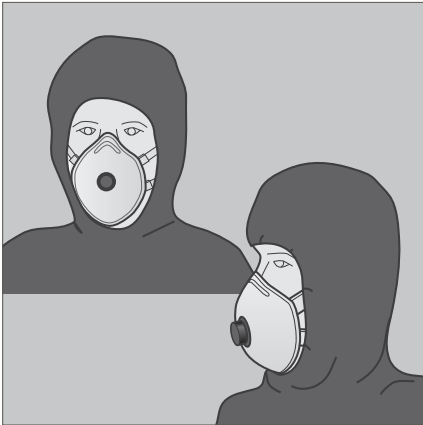

(A) Disposable,* half-face particulate respirator.

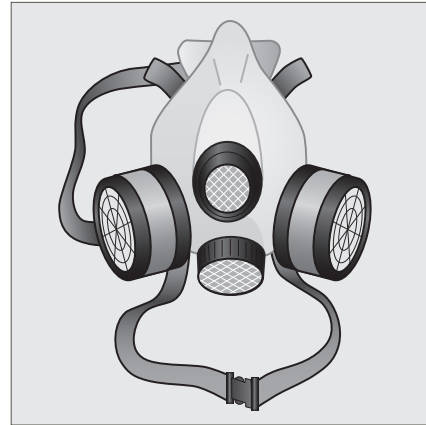

(B) Half-face, particulate filter (cartridge) respirator.



(C) Powered, air-purifying, ventilated helmet respirator.



(D) Full-face, particulate filter (cartridge) respirator.

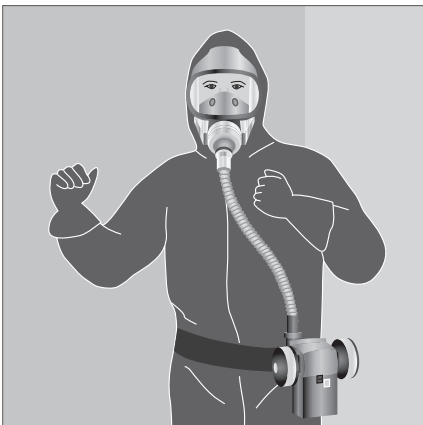

(E) Full-face, powered air-purifying particulate respirator.

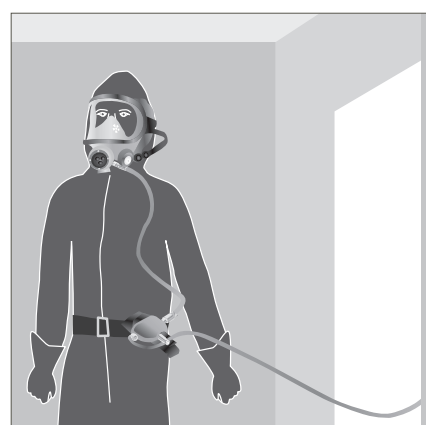

(F) Full-face, positive pressure demand air-line respirator.

* Disposable half-face respirators are not recommended for ongoing asbestos-related activities.

Appendix H – Selection and use of personal protective equipment and clothing for asbestos-related activities

Selection of appropriate respiratory equipment

Asbestos-related activity	Recommended respirator (minimum)	Filter type (where applicable)
Simple enclosure or sealing of undamaged ACM – no direct handling but likely exposure to airborne asbestos fibres	Disposable,* half-face particulate respirators or Half-face, particulate filter (cartridge) respirator	P1 or P2
Inspection of the condition of any installed asbestos friction materials (for example, automotive brakes), which appears in poor condition or has been disturbed	Disposable,* half-face particulate respirators or Half-face, particulate filter (cartridge) respirator	P1 or P2
Sampling material for the purpose of identifying asbestos	Disposable,* half-face particulate respirators or Half-face, particulate filter (cartridge) respirator	P1 or P2
For work with AC (fibro) (for example, hand drilling and sawing)	Disposable,* half-face particulate respirators or Half-face, particulate filter (cartridge) respirator	P1 or P2
For work with asbestos-based friction materials (for example, removal of automotive brake pads)	Disposable,* half-face particulate respirators or Half-face, particulate filter (cartridge) respirator	P1 or P2
Maintenance work in the vicinity of installed asbestos insulation – no direct handling but likely exposure to airborne asbestos fibres	Full-face, particulate, filter (cartridge) respirator	P3
Extensive sampling of suspected friable asbestos	Full-face, particulate, filter (cartridge) respirator or Full-face, positive pressure demand air-line respirator or Full suit or hood, continuous flow air-line respirator	P3

* Disposable half-face respirators are not recommended for ongoing asbestos-related activities.

Appendix I – Exposure standard and atmospheric monitoring

How is an employee's exposure to airborne asbestos fibres determined?

An employee's exposure to airborne asbestos fibres can be determined through atmospheric monitoring (also known as 'personal air monitoring' or 'exposure monitoring') and comparing the results with the asbestos exposure standard to determine if an employee's exposure to asbestos is excessive.

What is atmospheric monitoring?

Atmospheric monitoring involves the use of sampling and analytical techniques to obtain an estimate of the level of a person's (for example, employee) exposure to airborne asbestos fibres or contaminants.

What is the asbestos exposure standard?

The asbestos exposure standard for all forms of asbestos is 0.1 fibres per millilitre (0.1 f/ml) of air measured in a person's breathing zone and expressed as a time-weighted average fibre concentration of asbestos calculated over an eight hour working day and measured over a minimum of 4 hours in accordance with the membrane filter method or a method determined by WorkSafe under regulation 6 of the OHS Regulations. For more information see the SWA guidance note on the *Membrane filter method for estimating airborne asbestos fibres* 2nd Edition [NOHSC: 3003 (2005)].

Note: RPE should not be considered when establishing whether there is a risk of exposure to airborne asbestos fibres.

The exposure standard represents an airborne concentration of a particular substance (for example, asbestos) in a person's breathing zone.

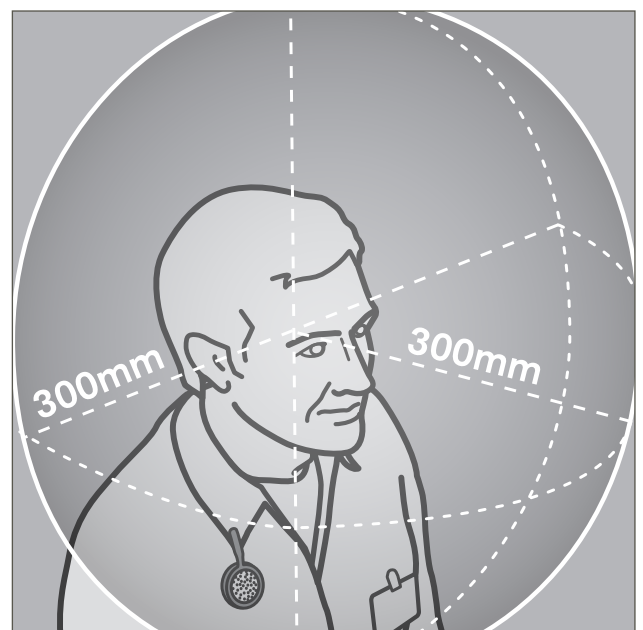

The breathing zone.

The breathing zone is defined as a hemisphere with a radius of 300mm extending in front of a person's face measured from the mid-point of an imaginary straight line joining the ears.

The asbestos exposure standard does not represent a 'risk free' level at which every employee can be guaranteed absolute protection from any asbestos related illness. Nor does the asbestos exposure standard constitute a 'fine line' between satisfactory and unsatisfactory working conditions.

Appendix I – Exposure standard and atmospheric monitoring

Results of atmospheric monitoring can only be directly compared to the exposure standard if monitoring was performed in the breathing zone of the employee over a continuous period of not less than four hours and the sample is considered representative of exposure.

The results of static or fixed position monitoring should not be used as an indicator of actual employee exposure to airborne asbestos fibres. However, in certain circumstances, static or fixed position monitoring can help in determining the design of risk controls or the effectiveness of existing risk controls.

When is atmospheric monitoring required?

An employer must ensure that a determination of an employee's exposure to airborne asbestos fibres at the workplace is carried out if there is uncertainty (based on reasonable grounds) as to whether the exposure standard has been exceeded. [OHS Regulations r211](#)

In other words, atmospheric monitoring is required if risk to health cannot be determined with confidence by simply reviewing the information about asbestos and examining the nature of the work.

The following are examples of situations where atmospheric monitoring may be needed to determine an employee's exposure to airborne asbestos fibres in the workplace due to uncertainty about whether there is a risk or the level of exposure.

- When reviewing the effectiveness of any measures implemented to control risks associated with an asbestos-related activity.
- To determine if the use of brooms, brushes, high-pressure water jets, power tools or similar tools or instruments as part of an asbestos-related activity is controlled in order to ensure that while in use a person is not likely to be exposed to airborne asbestos fibres exceeding one half the asbestos exposure standard (0.05 f/ml).
- To determine if the use of compressed air or other compressed gases within 6 metres of an asbestos-related activity does not result in airborne asbestos fibres that exceed one half of the asbestos exposure standard (0.05 f/ml).
- To assess exposure to airborne asbestos fibres relative to the exposure standard.

If it is obvious that there is potential for exposure to airborne asbestos fibres, priority needs to be given to controlling the risk rather than carrying out atmospheric monitoring just to confirm that the potential for exposure exists. However, once controls have been put in place their effectiveness can be determined by performing atmospheric monitoring.

For further information about atmospheric monitoring refer to relevant documented standards, technical journals or publications issued by WorkSafe and SWA. Further information and advice can be obtained from professionals such as occupational hygienists.

Who can conduct the atmospheric monitoring?

Atmospheric monitoring and the interpretation of the results (including comparison with the asbestos exposure standard) need to be undertaken by a person with the requisite knowledge, skills and experience, such as an occupational hygienist.

The Australian Institute of Occupational Hygienists (AIOH) is an incorporated institute that represents the occupational hygiene field both nationally and internationally. A list of service providers who may be able to conduct atmospheric monitoring can be found at aioh.org.au.

Appendix I – Exposure standard and atmospheric monitoring

Who can analyse the atmospheric monitoring samples?

The analysis of an asbestos sample (including an atmospheric monitoring sample involving asbestos) must be undertaken by an approved asbestos laboratory (for example, a laboratory approved by NATA) OHS Regulations r213(1).

The NATA website (nata.com.au) can be used to confirm whether a laboratory is approved by NATA.

What actions are required after atmospheric monitoring?

If atmospheric monitoring results indicate that risk control measures have deteriorated or are not effective, prompt action needs to be taken to reduce employee exposure to airborne asbestos fibres. Risk control measures need to be restored or improved as soon as possible. This may involve ceasing work while normal risk control measures are restored to the required level of effectiveness, providing portable or temporary ventilation, adopting modified work practices or providing PPE.

Results of atmospheric monitoring to be available

An employer must ensure that copies of the results of atmospheric monitoring for airborne asbestos fibres are readily accessible to the HSR of any affected DWG and to the affected employees. OHS Regulations r312 It is important that all atmospheric monitoring results are communicated to the employees involved, regardless of whether the results indicate excessive, minimal or no exposure to airborne asbestos fibres.

Appendix J – Sealing asbestos cement sheeting

The following is an example of a procedure that can be implemented to control the risk associated with sealing AC sheeting. The procedure used needs to be appropriate to the specific circumstances at the workplace.

An employer must ensure that, when carrying out an asbestos-related activity, the activity is carried out in a manner that, so far as is reasonably practicable, eliminates the release of airborne asbestos fibres. [OHS Regulations r306](#) This includes when carrying out the sealing of ACM.

Sealing should only be carried out on ACM that is in good condition. ACM needs to be thoroughly inspected before the work begins.

There is a risk of exposure to airborne asbestos fibres if the surface of AC sheeting has been disturbed (for example, from hail storms and strong winds) or if the sheeting has deteriorated due to work processes over time (for example, degradation due to chemical exposure) or other factors (for example, pollution). If AC sheeting is so weathered that its surface is cracked or broken, the AC matrix may be eroded, increasing the likelihood that asbestos fibres could become airborne.

Where practicable, sealing of AC products should be avoided and replacement considered instead.

If sealing of AC sheeting is undertaken, a method that does not disturb the matrix of the AC sheeting needs to be used. An airless spray gun at low pressure is recommended as rollers and brushes on exposed (or unsealed) asbestos may cause abrasion/damage and result in asbestos fibres being released from the surface of the material and becoming airborne.

ACM should not be water-blasted or dry-sanded in preparation for sealing. Cleaning AC sheeting in this way damages the surface, causing cement debris and asbestos fibres to be sprayed into the air. This can cause widespread contamination and puts the employee, occupier and any neighbours' health at risk.

Equipment

In addition to any equipment used to complete the particular task (eg paint, airless spray gun) the following equipment may be needed on site before the work begins:

- disposable cleaning rags
- bucket of water and/or a water spray bottle with a fine mist
- heavy-duty polythene sheeting (minimum 200 micron thickness)
- sealant
- spare PPE
- suitable asbestos waste container
- warning signs and/or barrier tape.

Personal protective equipment (PPE)

- See Appendix H for guidance on protective clothing.
- The minimum recommended RPE for this task is a non-disposable half-face respirator with a P1 filter or P2 filter, provided the recommended safe work procedure is followed. See Appendix H for guidance on selecting appropriate respirators.
- Where paint is to be applied, appropriate RPE to control the paint vapours/mist should also be considered.

Appendix J – Sealing asbestos cement sheeting

Preparing the asbestos work area

- If work is to be carried out at height, duties in relation to controlling the risk of falls apply. For more information see *WorkSafe's Prevention of falls in general construction compliance code (2018)* and *Prevention of falls in housing construction compliance code (2018)*.
- Before starting, assess the AC for damage.
- Ensure appropriately marked asbestos waste disposal bags are available.
- Carry out the work with as few people present as possible.
- Segregate the asbestos work area to ensure unauthorised personnel are restricted from entry (eg close doors and/or use warning signs and/or barrier tape at all entry points). The distance for segregation needs to be determined by a risk assessment.
- If possible, use heavy-duty polythene sheeting secured with cloth tape to cover any floor surface within the asbestos work area which could become contaminated.
- Ensure there is adequate lighting.
- If damp rags are used to prepare AC sheeting for sealing, do not re-soak used rags in a bucket of water as this will likely contaminate the water. Instead either fold the rag so a clean surface is exposed or dispose of it as asbestos waste and use another rag.
- Never use high-pressure water cleaning methods.
- Never prepare surfaces using dry-sanding methods. Where sanding is required consideration needs to be given to removing the ACM and replacing it with non-ACM.
- Wet sanding methods may be used to prepare the material provided precautions are taken to ensure all the runoff is captured and filtered where possible.
- Wipe dusty surfaces with a damp cloth.

Painting and sealing

- When using a spray brush, never use a high-pressure spray to apply the paint.
- When using a roller or brush, use it lightly to avoid abrasion or other damage.

Decontaminating the asbestos work area and equipment

- Use damp rags to clean the equipment.
- Use damp rags and/or a Dust Class H vacuum cleaner to clean the asbestos work area.
- Place debris, used rags, heavy-duty polythene sheeting and other waste in labelled asbestos waste bags/containers.
- Wet-wipe the external surfaces of the asbestos waste bags/containers to remove any adhering dust before they are removed from the asbestos work area.

Personal decontamination

Carry out the following personal decontamination procedure in a designated area:

- If disposable coveralls are worn for the activity, clean the coveralls and respirator while still wearing them. Coveralls can be cleaned using a Dust Class H vacuum cleaner, damp rag or fine-water spray and the respirator can be cleaned with a damp rag or cloth.
- While still wearing the respirator remove coveralls, turning them inside-out to entrap any remaining contamination and then place them into a labelled asbestos waste bag.
- Remove the respirator. If a non-disposable respirator was used inspect it to ensure it is free from contamination, clean it with a damp rag and store in a clean container. Disposable respirators must be placed in a sealed container, the exterior of which is decontaminated before the container is removed from the work area used for the activity.

Appendix J – Sealing asbestos cement sheeting

Clearance procedure

- Visually inspect the asbestos work area to make sure it has been properly cleaned.
- Consider seeking an independent person's visual assessment to confirm there is no visible asbestos residue.
- Dispose of all waste as asbestos waste.

Appendix K – Drilling of asbestos-containing material

The following is an example of a procedure that can be implemented to control the risk associated with the drilling of ACM. The procedure used needs to be appropriate to the specific circumstances at the workplace.

An employer must ensure that, when carrying out an asbestos-related activity, the activity is carried out in a manner that, so far as is reasonably practicable, eliminates the release of airborne asbestos fibres. OHS Regulations r306 This includes when carrying out the hand-drilling of ACM and any other activity that is likely to produce airborne asbestos fibres in excess of one half of the asbestos exposure standard.

It is recommended that ACM be removed without any drilling and replaced with a non-ACM. This is because drilling ACM is likely to release airborne asbestos fibres. A hand drill should be used instead of an electric powered drill because the quantity of asbestos fibres that can become airborne is likely to be significantly reduced. Additional requirements (such as personal air monitoring) may apply when using an electric powered drill on ACM.

Equipment

In addition to any equipment used to complete the particular task, the following equipment may be needed on-site before the work begins:

- A non-powered hand drill or a low-speed battery-powered drill.

Power tools (including battery or mains electricity powered drills) must not be used or caused to be used on asbestos unless the use is controlled (for more information see 'Use of certain tools or instruments on asbestos' on page 16).

The use of the tool is controlled, if, while in use the tool is enclosed or engineering controls (such as a local exhaust ventilation (LEV) dust control hood) are used, or a combination of both. If an LEV dust control hood cannot be attached and other dust control methods (such as pastes and gels) are unsuitable, then drilling should not be undertaken.

- Disposable cleaning rags.
- Bucket of water and/or a water spray bottle with a fine mist.
- Appropriate adhesive tape.
- Sealant.
- Spare PPE.
- A thickened substance, such as wallpaper paste, shaving cream or hair gel.
- A suitable asbestos waste container (eg 200 micron-thick asbestos waste bags or a drum, bin or skip lined with heavy-duty polythene sheeting (minimum 200 micron thickness)).
- Heavy-duty polythene sheeting (minimum 200 micron thickness).
- Warning signs and/or barrier tape.
- A Dust Class H vacuum cleaner.
- A sturdy paper, foam or thin metal cup or similar (for work on overhead surfaces only).

Appendix K – Drilling of asbestos-containing material

Personal protective equipment (PPE)

- See Appendix H for guidance on protective clothing.
- The minimum recommended RPE for this task is a non-disposable half-face respirator with a P1 filter or P2 filter, provided the recommended safe work procedure is followed. See Appendix H for guidance on selecting appropriate respirators.

Preparing the asbestos work area

- If the work is to be carried out at height, duties in relation to controlling the risk of falls apply. For more information see WorkSafe's *Prevention of falls in general construction compliance code (2018)* and *Prevention of falls in housing construction compliance code (2018)*.
- Ensure appropriately labelled asbestos waste disposal bags are available.
- Carry out the work with as few people present as possible.
- Segregate the asbestos work area to ensure unauthorised personnel are restricted from entry (eg close doors and/or use warning signs and/or barrier tape at all entry points). The distance for segregation needs to be determined by a risk assessment taking into account the area, the nature of the work and the type of asbestos etc.
- If drilling a roof from outside, segregate the area below.
- If access is available at the rear of the AC, segregate this area as well.
- If possible, use heavy-duty polythene sheeting secured with appropriate adhesive tape to cover any surface within the asbestos work area that could become contaminated.
- Ensure there is adequate lighting.
- Avoid working in windy environments where asbestos fibres can become airborne.

- If using a bucket of water, do not re-soak used rags in the bucket as this will contaminate the water. Instead either fold the rag so a clean surface is exposed or dispose of as asbestos waste and use another rag.

Drilling vertical surfaces

- Tape both the point to be drilled and the exit point (if accessible) with a strong adhesive tape (for example, cloth tape) to prevent the edges crumbling.
- Cover the drill entry and exit points (if accessible) on the ACM with a generous amount of a thickened substance, such as wallpaper paste, shaving cream or hair gel.
- Drill through the paste.
- Withdraw the drill and use damp rags to clean off the paste from it and any debris from the wall.
- Dispose of the rags as asbestos waste as they will likely contain asbestos fibres.
- Seal the cut edges with sealant.
- If a cable is to be passed through insert a sleeve to protect the inner edge of the hole.

Appendix K – Drilling of asbestos-containing material

Drilling overhead horizontal surfaces

- Mark the point to be drilled.
- Drill a hole through the bottom of the cup.
- Fill or line the inside of the cup with shaving cream, gel or a similar thickened substance.
- Put the drill bit through the hole in the cup so that the cup encloses the drill bit and make sure the drill bit extends beyond the lip of the cup.
- Align the drill bit with the marked point.
- Ensure the cup is firmly held against the surface to be drilled.
- Drill through the surface.
- Remove the drill bit from the cup, ensuring that the cup remains firmly against the surface.
- Remove the cup from the surface.
- Use damp rags to clean off the paste and debris from the drill bit and the wall.
- Dispose of the rags as asbestos waste as they will contain asbestos fibres.
- Seal the cut edges with sealant.
- If a cable is to be passed through, insert a sleeve to protect the inner edge of the hole.

Decontaminating the asbestos-related activity area and equipment

- Use damp rags to clean the equipment including the drill.
- If needed, use damp rags or a Dust Class H vacuum cleaner to collect any loose debris on any heavy-duty polythene sheeting used to cover any surface within the asbestos work area.
- Carefully roll or fold any heavy-duty polythene sheeting used to cover any surface within the asbestos work area so as not to spill any dust or debris that has been collected.
- Use damp rags and/or a Dust Class H vacuum cleaner to clean any remaining visibly contaminated sections of the asbestos work area.
- Place debris, used rags, heavy-duty polythene sheeting and other waste (for example, drill bits that have not been decontaminated) in the labelled asbestos waste bags/container.
- Wet-wipe the external surfaces of the asbestos waste bags/container to remove any dust before they are removed from the asbestos work area.

Appendix K – Drilling of asbestos-containing material

Personal decontamination

Carry out the following personal decontamination procedure in a designated area:

- If disposable coveralls are worn for the activity, clean the coveralls and respirator while still wearing them. Coveralls can be cleaned using a Dust Class H vacuum cleaner, damp rag or fine-water spray and the respirator can be cleaned with a damp rag or cloth.
- While still wearing the respirator remove coveralls, turning them inside-out to entrap any remaining contamination and then place them into a labelled asbestos waste bag.
- Remove the respirator. If a non-disposable respirator was used, inspect it to ensure it is free from contamination, clean it with a damp rag and store in a clean container. Disposable respirators must be contained, the exterior of the container must indicate the presence of asbestos and be decontaminated before being removed from the work area used for the activity.

Clearance procedure

- Visually inspect the asbestos work area to make sure it has been properly cleaned.
- Consider seeking an independent person's visual assessment to confirm there is no visible asbestos residue.
- Dispose of all waste as asbestos waste.

Appendix L – Cleaning debris from asbestos cement roof gutters

The following is an example of a procedure that can be implemented to control the risk associated with cleaning debris from AC roof gutters. The procedure used needs to be appropriate to the specific circumstances at the workplace.

An employer must ensure that, when carrying out an asbestos-related activity, the activity is carried out in a manner that, so far as is reasonably practicable, eliminates the release of airborne asbestos fibres. [OHS Regulations r306](#) This includes when carrying out any activity that is likely to produce airborne asbestos fibres in excess of one half of the asbestos exposure standard.

Cleaning should only be carried out on ACM that is in good condition. ACM should be thoroughly inspected before the work begins.

If the condition of the AC roof gutters has deteriorated or ACM debris are present an asbestos removal licence holder may be required to undertake asbestos removal work (for more information see 'Asbestos removal work' on page 50).

Equipment

In addition to any equipment used to complete the particular task, the following equipment may also be needed on-site before the work begins:

- bucket of water and detergent
- watering can or garden spray with a fine spray nozzle
- hand trowel or scoop
- disposable cleaning rags
- suitable asbestos waste container
- warning signs and/or barrier tape
- Dust Class H vacuum cleaner.

Personal protective equipment (PPE)

- See Appendix H for guidance on protective clothing.
- The minimum recommended RPE for this task is a non-disposable half-face respirator with a P1 filter or P2 filter, provided the recommended safe work procedure is followed. See Appendix H for guidance on selecting appropriate respirators.

Preparing the asbestos work area

- Since the work is to be carried out at height, appropriate precautions must be taken to prevent the risk of falls. For more information see *WorkSafe's Prevention of falls in general construction compliance code (2018)* and *Prevention of falls in housing construction compliance code (2018)*.
- Ensure appropriately marked asbestos waste disposal containers are available.
- Segregate the asbestos work area to ensure unauthorised personnel are restricted from entry (for example, use warning signs and/or barrier tape at all entry points). The distance for segregation needs to be determined by a risk assessment.
- Segregate the area below.
- Consider the use of drop sheets.
- Avoid working in windy environments where asbestos fibres can become airborne.
- If using a bucket of water do not re-soak used rags in the bucket as this will contaminate the water. Instead either fold the rag so a clean surface is exposed or dispose of as asbestos waste and use another rag.

Appendix L – Cleaning debris from asbestos cement roof gutters

Gutter cleaning

- Disconnect or re-route the downpipes to prevent any entry of contaminated water into the waste water system and ensure there is a suitable container to collect contaminated run-off. Asbestos contaminated water must be disposed of as asbestos waste.
- Mix the water and detergent.
- Using the watering can or garden spray pour the water and detergent mixture into the gutter but avoid over-wetting as this will create slurry.
- Remove the debris using a scoop or trowel. Do not allow debris or slurry to enter the water system.
- Wet the debris again if dry material is uncovered.
- Place the removed debris straight into the asbestos waste container.

Decontaminating the asbestos work area and equipment

- Use damp rags to wipe down all equipment used.
- Use damp rags to wipe down the guttering.
- If necessary (and where practicable), use a Dust Class H vacuum cleaner to vacuum the area below.
- Place debris, used rags and other waste in a labelled asbestos waste container.
- Wet-wipe the external surfaces of the asbestos waste container to remove any dust before it is removed from the asbestos work area.

Personal decontamination

Carry out the following personal decontamination procedure in a designated area:

- If disposable coveralls are worn for the activity, clean the coveralls and respirator while still wearing them. Coveralls can be cleaned using a Dust Class H vacuum cleaner, damp rag or fine-water spray and the respirator can be cleaned with a damp rag or cloth.
- While still wearing the respirator remove coveralls, turning them inside-out to entrap any remaining contamination and then place them into a labelled asbestos waste bag.
- Remove the respirator. If a non-disposable respirator was used, inspect it to ensure it is free from contamination, clean it with a damp rag and store in a clean container. Disposable respirators must be contained, the exterior of the container must indicate the presence of asbestos and be decontaminated before being removed from the work area used for the activity.

Clearance procedure

- Visually inspect the asbestos work area, paying particular attention to the ground below for any spoil and debris to make sure it has been properly cleaned. Where the clean-up/removal exceeds the thresholds for limited asbestos removal work an asbestos removal licence holder is required to undertake asbestos removal work (for more information see 'Asbestos removal work' on page 50).
- Clearance air sampling is not normally required for this task.
- Dispose of all waste, including all water, as asbestos waste.

Appendix M – Replacing cabling in asbestos cement conduits or boxes

The following is an example of a procedure that can be implemented to control the risk associated with replacing cabling in AC conduits or boxes. The procedure used needs to be appropriate to the specific circumstances at the workplace.

An employer must ensure that, when carrying out an asbestos-related activity, the activity is carried out in a manner that, so far as is reasonably practicable, eliminates the release of airborne asbestos fibres. [OHS Regulations r306](#) This includes when carrying out any activity that is likely to produce airborne asbestos fibres in excess of one half of the asbestos exposure standard.

Caution – use of water and electrical hazards

In general, damp rags are used to clean asbestos material to reduce the potential for dust to become airborne during asbestos-related activities (and removal). However, the use of water in this manner may present a risk of electrocution where there is live electricity in the vicinity. Damp rags should only be used to wet ACM if electricity in the work area has been isolated by a licensed electrical contractor.

Equipment

In addition to any equipment used to complete the particular task, the following equipment may also be needed on-site before the work begins:

- Disposable cleaning rags.
- Bucket of water or a water spray bottle with a fine mist.
- Heavy-duty polythene sheeting (minimum 200 micron thickness).
- Cable slipping compound.
- Appropriately marked asbestos waste disposal bags.
- Spare PPE.
- Appropriate adhesive tape.
- Warning signs and/or barrier tape.
- Dust Class H vacuum cleaner.

Personal protective equipment (PPE)

- See Appendix H for guidance on protective clothing.
- The minimum recommended RPE for this task is a non-disposable half-face respirator with a P1 filter or P2 filter, provided the recommended safe work procedure is followed. See Appendix H for guidance on selecting appropriate respirators.

Appendix M – Replacing cabling in asbestos cement conduits or boxes

Preparing the asbestos work area

- If the work will be carried out in a confined space, duties in relation to working in confined spaces apply. For more information see WorkSafe's *Confined spaces compliance code* (2018).
- Ensure appropriately marked asbestos waste disposal bags are available.
- Carry out the work with as few people present as possible.
- Segregate the asbestos work area to ensure unauthorised personnel are restricted from entry (eg use warning signs and/or barrier tape at all entry points). The distance for segregation needs to be determined by a risk assessment.
- Use heavy-duty polythene sheeting secured with appropriate adhesive tape to cover any surface within the asbestos work area which could become contaminated.
- Place heavy-duty polythene sheeting below the conduits through which cables are to be pulled.
- Ensure there is adequate lighting.
- Avoid working in windy environments where asbestos fibres can become airborne.
- If using a bucket of water do not re-soak used rags in the bucket as this will contaminate the water. Instead either fold the rag so a clean surface is exposed or dispose of as asbestos waste and use another rag.

Replacement or installation of cables

- Wet down the equipment and apply adequate cable slipping compound to the conduits/ducts throughout the process.
- Clean all ropes, rods or snakes used to pull cables after use. Cleaning needs to be undertaken close to the points where the cables exit from the conduits/ducts. Consider using sleeves on ducts to protect exposed edges.
- Ropes used for cable pulling need to have a smooth surface that can easily be cleaned.
- Do not use metal stockings when pulling cables through AC conduits.
- Do not use compressed air darts for pulling cables through AC conduits/ducts.

Appendix M – Replacing cabling in asbestos cement conduits or boxes

Decontaminating the asbestos work area and equipment

- Use damp rags to clean the equipment.
- Wet-wipe around the end of the conduit, sections of exposed cable and the pulling eye at the completion of the cable pulling operation.
- If the rope or cable passes through any rollers on cable pulling equipment these need to be wet-wiped after use.
- Wet-wipe the external surface of excess cable pulled through the conduit/duct as close as possible to the exit point from the conduit before it is removed from the work site.
- If required use damp rags or a Dust Class H vacuum cleaner to collect any loose debris on any heavy-duty polythene sheeting used to cover any surface within the asbestos work area.
- Carefully roll or fold any heavy-duty polythene sheeting used to cover any surface within the asbestos work area so as not to spill any dust or debris that has been collected.
- If required use damp rags or a Dust Class H vacuum cleaner to clean any remaining visibly contaminated sections of the asbestos work area.
- Place all debris, used rags, heavy-duty polythene sheeting and other waste in the asbestos waste bags/container.
- Wet-wipe the external surfaces of the asbestos waste bags/container to remove any adhering dust before they are removed from the asbestos work area.

Personal decontamination

Carry out the following personal decontamination procedure in a designated area:

- If disposable coveralls are worn for the activity, clean the coveralls and respirator while still wearing them. Coveralls can be cleaned using a Dust Class H vacuum cleaner, damp rag or fine-water spray and the respirator can be cleaned with a damp rag or cloth.
- While still wearing the respirator remove coveralls, turning them inside-out to entrap any remaining contamination and then place them into a labelled asbestos waste bag.
- Remove the respirator. If a non-disposable respirator was used, inspect it to ensure it is free from contamination, clean it with a damp rag and store in a clean container. Disposable respirators must be contained, the exterior of the container must indicate the presence of asbestos and be decontaminated before being removed from the work area used for the activity.

Clearance procedure

- Visually inspect the asbestos work area to make sure it has been properly cleaned.
- Consider seeking an independent person's visual assessment to confirm there is no visible asbestos residue.
- Dispose of all waste as asbestos waste.

Appendix N – Working on electrical mounting boards (switchboards) containing asbestos

The following is an example of a procedure that can be implemented to control the risk associated with working on ACM electrical mounting boards. The procedure used needs to be appropriate to the specific circumstances at the workplace.

An employer must ensure that, when carrying out an asbestos-related activity, the activity is carried out in a manner that, so far as is reasonably practicable, eliminates the release of airborne asbestos fibres. [OHS Regulations r306](#) This includes when carrying out any activity that is likely to produce airborne asbestos fibres in excess of one half of the asbestos exposure standard.

If the condition of electrical mounting boards has deteriorated or ACD is present an asbestos removal licence holder may be required to undertake asbestos removal work (for more information see 'Asbestos removal work' on page 50).

Equipment

In addition to any equipment used to complete the particular task, the following equipment may also be needed on-site before the work begins:

- A non-powered hand drill or a low-speed battery-powered drill.

Power tools (including battery or mains powered drills) must not be used or caused to be used on asbestos unless the use is controlled (for more information see 'Use of certain tools or instruments on asbestos' on page 16).

The use of the tool is controlled, if, while in use the tool is enclosed or engineering controls (such as a local exhaust ventilation (LEV) dust control hood) are used, or a combination of both. If an LEV dust control hood cannot be attached and other dust control methods (such as pastes and gels) are unsuitable, then drilling should not be undertaken.

- Appropriate adhesive tape.
- Warning signs and/or barrier tape.
- Disposable cleaning rags.
- Spare PPE.
- Suitable asbestos waste container.
- Heavy-duty polythene sheeting (minimum 200 micron thickness).
- Dust Class H vacuum cleaner.
- Cleaning rags.
- Water spray bottle with a fine mist (for cleaning the equipment after the activity is finished and also for cleaning the asbestos waste bags prior to removing them from the asbestos-related activity area).

Appendix N – Working on electrical mounting boards (switchboards) containing asbestos

Personal protective equipment (PPE)

- See Appendix H for guidance on protective clothing.
- The minimum recommended RPE for this task is a non-disposable half-face respirator with a P1 filter or P2 filter, provided the recommended safe work procedure is followed. See Appendix H for guidance on selecting appropriate RPE.

Preparing the asbestos work area

- If work is to be carried out near electrical hazards, risks associated with electrocution and electric shock must be controlled.
- Ensure appropriately marked asbestos waste disposal bags are available.
- Carry out the work with as few people present as possible.
- Segregate the asbestos work area to ensure unauthorised personnel are restricted from entry (eg use warning signs and/or barrier tape at all entry points). The distance for segregation needs to be determined by a risk assessment.
- Use heavy-duty polythene sheeting secured with appropriate adhesive tape to cover any surface within the asbestos work area which could become contaminated.
- Ensure there is adequate lighting.
- Avoid working in windy environments where asbestos fibres can become airborne.
- Use the Dust Class H vacuum cleaner to remove any dust from the work area prior to commencing the asbestos-related activity.

Work on electrical mounting panels

Providing the panel is not friable, maintenance and service work may include:

- The replacement of asbestos-containing components/equipment on the electrical panel with non-asbestos-containing components/equipment.
- The operation of main switches and individual circuit devices.
- Pulling/inserting service and circuit fuses.
- Bridging supplies at meter bases.
- Using testing equipment.
- Accessing the neutral link.
- The installation of new components/equipment.

A person must not re-use any asbestos (see 'Supply, storage, transport, sale, use, re-use, installation and replacement of asbestos' on page 11). [OHS Regulations r224\(c\)](#) For example, if an ACM electrical mounting panel has to be removed, it must be replaced with non-ACM. Asbestos removal work must be performed in accordance with 'Division 7 – Removal of asbestos' in 'Part 4.4 – Asbestos' of the OHS Regulations. For more information about asbestos removal work see page 15 of WorkSafe's *Removing asbestos in workplaces compliance code* (2018).

If drilling is required, the control process needs to follow the measures described in Appendix K.

Appendix N – Working on electrical mounting boards (switchboards) containing asbestos

Decontaminating the asbestos work area and equipment

- In areas where there is an electrical hazard, a Dust Class H vacuum cleaner needs to be used to remove any dust or debris from the mounting panel and other visibly contaminated sections of the asbestos work area.
- Avoid electrocution hazard – only use a water spray bottle and damp rags to clean the equipment after completing the activity.
- Carefully roll or fold any heavy-duty polythene sheeting used to cover any surface within the asbestos work area so as not to spill any dust or debris that has been collected.
- Pick up larger pieces of debris (if any) by hand and vacuum dust and smaller debris.
- Place debris, used rags, heavy-duty polythene sheeting and other waste in the asbestos waste bags/container.
- Spray and wet-wipe the external surfaces of the asbestos waste bags/container to remove any adhering dust before they are removed from the asbestos work area.

Personal decontamination

Carry out the following personal decontamination procedure in a designated area:

- If disposable coveralls are worn for the activity clean the coveralls and respirator while still wearing them. Coveralls can be cleaned using a Dust Class H vacuum cleaner, damp rag or fine-water spray and the respirator can be cleaned with a damp rag or cloth.
- While still wearing the respirator remove coveralls, turning them inside-out to entrap any remaining contamination and then place them into a labelled asbestos waste bag.
- Remove the respirator. If a non-disposable respirator was used inspect it to ensure it is free from contamination, clean it with a damp rag and store in a clean container. Disposable respirators must be contained, the exterior of the container must indicate the presence of asbestos and be decontaminated before being removed from the work area used for the activity.

Clearance procedure

- Visually inspect the asbestos work area to make sure it has been properly cleaned.
- Consider seeking an independent person's visual assessment to confirm there is no visible asbestos residue.
- Dispose of all waste, including all water, as asbestos waste.

Appendix O – Working with asbestos friction materials and high-temperature gaskets

The following is an example of procedures that can be implemented to control the risk associated with working on ACM friction materials and high-temperature gaskets. The procedure used needs to be appropriate to the specific circumstances at the workplace.

An employer must ensure that, when carrying out an asbestos-related activity, the activity is carried out in a manner that, so far as is reasonably practicable, eliminates the release of airborne asbestos fibres. [OHS Regulations r306](#) This includes the handling, including for the purposes of removal, of automotive components that are ACM or that have ACM fixed to them or installed in them and any other activity that is likely to produce airborne asbestos fibres in excess of one half of the asbestos exposure standard.

Replacing, servicing or repairing asbestos containing brakes, clutches and high-temperature gaskets on motor vehicles (and other plant) must be undertaken in a way that controls the risk of exposure to airborne asbestos fibres in accordance with the OHS Regulations.

Practical methods of reducing the spread of asbestos fibres

If the following simple controls are applied carefully, it generally should not be necessary to carry out air monitoring in the workshop while servicing vehicle brakes, clutches and cylinder head/exhaust gaskets.

Using a Dust Class H vacuum cleaner

Dust Class H vacuum cleaners need to be used to clean ACD from components and other parts in the immediate vicinity (for more information see 'Using and emptying Dust Class H vacuum cleaners' on page 65).

It may be necessary to purchase or fabricate special hose nozzles to reach areas that are difficult to access to ensure components are effectively cleaned of ACD. Any residual ACD needs to be removed with a damp rag.

Using a water spray bottle

A water spray bottle with a fine mist will dampen and suppress airborne ACD. The component and parts in the immediate vicinity should be wiped down with a damp rag. Rags used for asbestos-related activities are asbestos waste and must be contained and disposed of as soon as reasonably practicable in an appropriate manner that eliminates the release of airborne asbestos fibres. Any spillage onto the workshop floor needs to be wiped up and disposed of in the same way. It is important that only a gentle misting spray is used as a coarse spray may disperse the asbestos fibres into the air. A respirator certified by the manufacturer as suitable for ACD needs to be worn during the above cleaning processes. The minimum recommended RPE for this task is a non-disposable half-face respirator with a P1 filter or P2 filter.

Compressed air, water hoses and aerosol cans should not be used to clean ACD off components as these methods are likely to disperse asbestos fibres into the air.

Appendix O – Working with asbestos friction materials and high-temperature gaskets

Dedicated asbestos-handling area

An employer must ensure that the work area used for an asbestos-related activity is kept separate from any other work area and, so far as is reasonably possible, has appropriately placed signs and barricades that indicate the area where the activity is being carried out.

OHS Regulations r309 The work area where asbestos components are removed needs to be in a location where wind or cooling fans will not disturb any ACD.

How to apply these controls to typical workshop jobs

1. Brake assembly repairs – vacuum method (preferred method)
 - Consider the physical work environment and surrounding activities so the work area is not disturbed. For example, segregate the vehicle from surrounding work areas and try to have at least three metres separation and avoid windy locations and cooling fans etc.
 - Use portable signs to indicate that asbestos removal is going on.
 - Wear a non-disposable half-face respirator with a P1 filter or P2 filter.
 - Use a Dust Class H vacuum cleaner to clean the wheel prior to undoing the wheel nuts.
 - Remove the wheel and vacuum any remaining dust on the wheel.
 - Vacuum all dust off the brake assembly.
 - Use a wet rag to wipe down all parts and remove any final traces of dust.
 - Vacuum any additional dust that is exposed during disassembly.
 - Place the removed component and used rags etc into a plastic bag and seal or tie it and then place it into a marked plastic-lined bin or skip for disposal as asbestos waste (see Disposal section on page 115).
2. Brake assembly repairs – wet method
 - Consider the physical work environment and surrounding activities so the work area is not disturbed. For example, segregate the vehicle from surrounding work areas and try to have at least three metres separation and avoid windy environments and cooling fans etc.
 - Use portable signs to indicate that asbestos removal is going on.
 - Wear a non-disposable half-face respirator with a P1 filter or P2 filter.
 - Place a tray or tape heavy-duty polythene sheeting to the floor under the removal area to catch spillage and to make clean up easier.
 - Use a damp rag to clean the wheel and wipe off any dust prior to removing the wheel nuts.
 - Remove the wheel and clean off any remaining dust with the wet rag.
 - Use a damp rag and gentle water mist to thoroughly damp down any dust on the brake assembly.
 - Use a damp rag to wipe off any further dust following disassembly. Wipe up any spillage on the floor.
 - Place removed component and used rags etc in a plastic bag and seal or tie it and then place it into a marked plastic-lined bin or skip for disposal as asbestos waste (see Disposal section on page 115).

Appendix O – Working with asbestos friction materials and high-temperature gaskets

3. Clutch repairs
 - Consider the physical work environment and surrounding activities so the work area is not disturbed. For example, segregate the vehicle from surrounding work areas and try to have at least three metres separation and avoid windy locations and cooling fans etc.
 - Use portable signs to indicate that asbestos removal is going on.
 - Wear a non-disposable half-face respirator with a P1 filter or P2 filter.
 - After separating the gearbox from the engine, vacuum/wipe with a damp rag inside the bell housing and around the pressure plate.
 - On removal of the pressure plate and clutch plate, vacuum/wipe with a damp rag the flywheel, housing and components.
 - Place removed components and used rags in a plastic bag and seal or tie it and then place it into a marked plastic-lined bin or skip for disposal as asbestos waste (see Disposal section on page 115).
4. Cylinder head and exhaust gaskets
 - Segregate the vehicle from surrounding work areas. Try to have at least three metres separation and avoid windy locations and cooling fans etc.
 - Use portable signs to indicate that asbestos removal is going on.
 - Wear a non-disposable half-face respirator with a P1 filter or P2 filter.
 - If the gasket is damaged during separation of the components, damp down with water to control asbestos fibres.
 - Keep the gasket wet and carefully remove it.
 - Wipe down the joint faces and the immediate area with a damp rag.
 - Place removed gasket and used rags in a plastic bag and seal or tie it and then place it into a marked plastic-lined bin or skip for disposal as asbestos waste (see Disposal section on page 115).

Disposal

Asbestos waste (including ACM components and used wiping rags) must be disposed of as soon as reasonably possible in an appropriate manner that eliminates the release of airborne asbestos fibres. Asbestos waste needs to be double bagged in two 200 micron-thick asbestos waste bags and clearly labelled to identify the presence of asbestos. An example of appropriate wording is: **'Caution Asbestos – Do not open or damage bag. Do not inhale dust'**.

Asbestos waste awaiting disposal at the workshop must be contained so as to eliminate the release of airborne asbestos fibres in a container indicating the presence of asbestos (for example, in 60 or 200 litre steel drums with removable lids or a sealed skip).

Asbestos waste must be transported and disposed of in accordance with EPA Victoria requirements. Asbestos waste must be disposed of at a waste disposal site licensed or exempted by the EPA.

Appendix P – Examples of asbestos-containing materials

- A**
- Air-conditioning ducts – exterior or interior acoustic and thermal insulation
 - Arc shields in lift motor rooms or large electrical cabinets
 - Asbestos-based plastics products – as electrical insulates and acid-resistant compositions or aircraft seats
 - Autoclave/steriliser insulation
- B**
- Bitumen-based water proofing such as malthoid (typically on roofs and floors but also in brickwork)
 - Bituminous adhesives and sealants
 - Boiler gaskets
 - Boiler insulation, slabs and wet mix
 - Brake disc pads
 - Brake linings
- C**
- Cable penetration insulation bags
 - Calorifier insulation
 - Car body filters (not common)
 - Caulking compounds, sealant and adhesives
 - Ceiling tiles
 - Cement conduits
 - Cement electrical fuse boards
 - Cement external roofs and walls
 - Cement in the use of form work when pouring concrete
 - Cement internal flues and downpipes
 - Cement moulded products, such as gutters, ridge cappings, gas meter covers, cable troughs and covers
 - Cement pieces for packing spaces between floor joists and piers
 - Cement underground pits, as used for traffic control wiring and telecommunications cabling
 - Cement render, plaster, mortar and coursework
 - Cement roof tiles
 - Cement sheet
 - Cement sheet behind ceramic tiles
 - Cement sheet internal over exhaust canopies, such as ovens and fume cupboards
 - Cement sheet internal walls and ceilings
 - Cement sheet underlays for vinyl
 - Cement storm drain pipes
 - Cement water pipes (usually underground)
 - Chrysotile wicks in kerosene heaters
 - Clutch faces
 - Compressed AC panels for flooring, verandas, bathrooms and steps for demountable buildings
 - Compressed asbestos fibres (CAF) used in brakes and gaskets for plant and vehicles
- D**
- Door seals on ovens
- E**
- Electric heat banks – block insulation
 - Electric hot water services (normally not asbestos but some millboard could be present)
 - Electric light fittings, high wattage, insulation around fitting (and bituminised)

Appendix P – Examples of asbestos-containing materials

Electrical switchboards (see pitch-based)

Exhausts on vehicles

F

Felts

Filler in acetylene gas cylinders

Filters – beverage, wine filtration

Fire blankets

Fire curtains

Fire door insulation

Fire-rated wall rendering containing asbestos with mortar

Fire-resistant plaster board, typically on ships

Fire-retardant material on steel work supporting reactors on columns in refineries in the chemical industry

Flexible hoses

Floor vinyl sheets

Floor vinyl tiles

Fuse blankets and ceramic fuses in switchboards

G

Galbestos™ roofing materials (decorative coating on metal roofs for sound proofing)

Gaskets – chemicals, refineries

Gaskets – general

Gauze mats in laboratories/chemical refineries

Gloves – for insulation against heat

H

Hairdryers – insulation around heating elements

Header (manifold) insulation

I

Insulation blocks

Insulation in electric reheat units for air-conditioner systems

L

Laboratory bench tops

Laboratory fume cupboard panels

Laboratory ovens – wall insulation

Lagged exhaust pipes on emergency power generators

Lagging in penetrations in fireproof walls

Laminates (eg Formica) used where heat resistance is required (eg ships)

Lifts shafts – AC panels lining the shaft at the opening of each floor and asbestos packing around penetrations

Limpet asbestos spray insulation

Locomotives (steam) lagging on boilers, steam lines, steam dome and gaskets

M

Marine board (eg marinate)

Mastics

Mattresses used for covering hot equipment in power stations

Millboard between heating units and walls

Millboard lining of switchboxes

Mortar

Appendix P – Examples of asbestos-containing materials

P

Packing materials for gauges, valves etc – can be square packing, rope or loose fibre

Packing material on window anchorage points in high-rise buildings

Paint (typically industrial epoxy paints)

Penetrations through concrete slabs in high-rise buildings

Paper used variously for insulation, filtering and production of fire resistant laminates

Pegboard

Pipe insulation including moulded sections, water-mix type, rope braid and sheet

Pitch-based (eg Zelemite, Ausbestos, Lebah) electrical switchboards

Plaster and plaster cornice adhesives

Pump insulation

R

Refractory linings

Refractory tiles

Rubber articles (extent of usage unknown)

S

Sealant between floor slab and wall, usually in boiler rooms, risers or lift shafts

Sealant or mastik on windows

Sealants and mastics in air-conditioning ducting joints

Spackle or plasterboard wall-jointing compounds

Sprayed insulation – acoustic wall and ceiling

Sprayed insulation – beams and ceiling slabs

Sprayed insulation – fire retardant sprayed on nut internally, for bolts holding external building wall panels

Stoves – old domestic type, wall insulation

T

Tape and rope – lagging and jointing

Tapered ends of pipe lagging (where lagging is not necessarily asbestos)

Textiles

Textile gussets in air-conditioning ducting systems

Tilux sheeting in place of ceramic tiles in bathrooms

Trailing cable under lift cabins

Trains, guards vans, millboard between heater and wall

Trains – Harris cars (sprayed asbestos between steel shell and laminex)

V

Valve insulation

W

Welding rods

Woven asbestos cable sheath

Y

Yarn

Appendix Q – Information required to be included in an asbestos control plan

OHS Regulations Schedule 12

The following information must be included in an asbestos control plan:

1. A record to indicate that the notification requirements have been met and that required documentation is kept at the workplace where the asbestos removal work is being performed.
2. In relation to asbestos:
 - its location
 - the quantity of asbestos proposed to be removed
 - in relation to ACM:
 - whether the ACM is friable or non-friable
 - the type of ACM
 - the condition of the ACM.
3. The type of personal protective clothing and PPE to be used, including RPE.
4. Proposed risk control measures to be used to prevent release of airborne asbestos fibres from the area where the asbestos removal work is being performed.
5. If the area where the asbestos removal work is being performed in a negative air enclosure, details regarding:
 - smoke testing
 - negative air units.
6. Details of decontamination procedures for:
 - persons performing the asbestos removal work
 - tools and equipment used for the asbestos removal work
 - non-disposable personal protective clothing and PPE.
7. Method of disposal of:
 - asbestos waste
 - disposable personal protective clothing and PPE
 - the structure used to enclose the areas where the asbestos removal work is being performed.
8. Administrative controls to be implemented, including:
 - security
 - work practices.
9. Methods of cleaning following asbestos removal work.
10. Names of persons engaged by the licence holder or person who commissioned the asbestos removal work (as applicable) to conduct asbestos paraoccupational air monitoring (if any) and to conduct the clearance inspection.
11. Name of any independent contractors engaged by the asbestos removal licence holder to perform asbestos removal work.

Appendix R – Documents associated with this compliance code

The references listed are not incorporated into this Code; they are included to provide an indication of sources of additional information. This means the references do not form part of this Code. Note that some references may have legal status in their own right.

Safe Work Australia Code of Practice, 2016, *How to manage and control asbestos in the workplace*

Safe Work Australia, 2013, *Health monitoring for exposure to hazardous chemicals (asbestos part)*



WorkSafe Agents

Agent contact details are all available at
worksafe.vic.gov.au/agents

Advisory Service

Toll-free 1800 136 089

Email info@worksafe.vic.gov.au

Head Office

1 Malop Street, Geelong 3220

Phone (03) 4243 7000

Toll-free 1800 136 089

Website worksafe.vic.gov.au

Information in your language

For information about WorkSafe in your own language, call our Translating and Interpreting Service (TIS National) on **131 450**.